

 SPORTLINE

ADVENTURE

 **GENESIS**

THE ORIGINAL **ADVENTURE** BICYCLE BRAND

 **RIDGEBACK**

SARACEN

Translation of the Original instruction manual

Bicycle parts/city and touring bikes

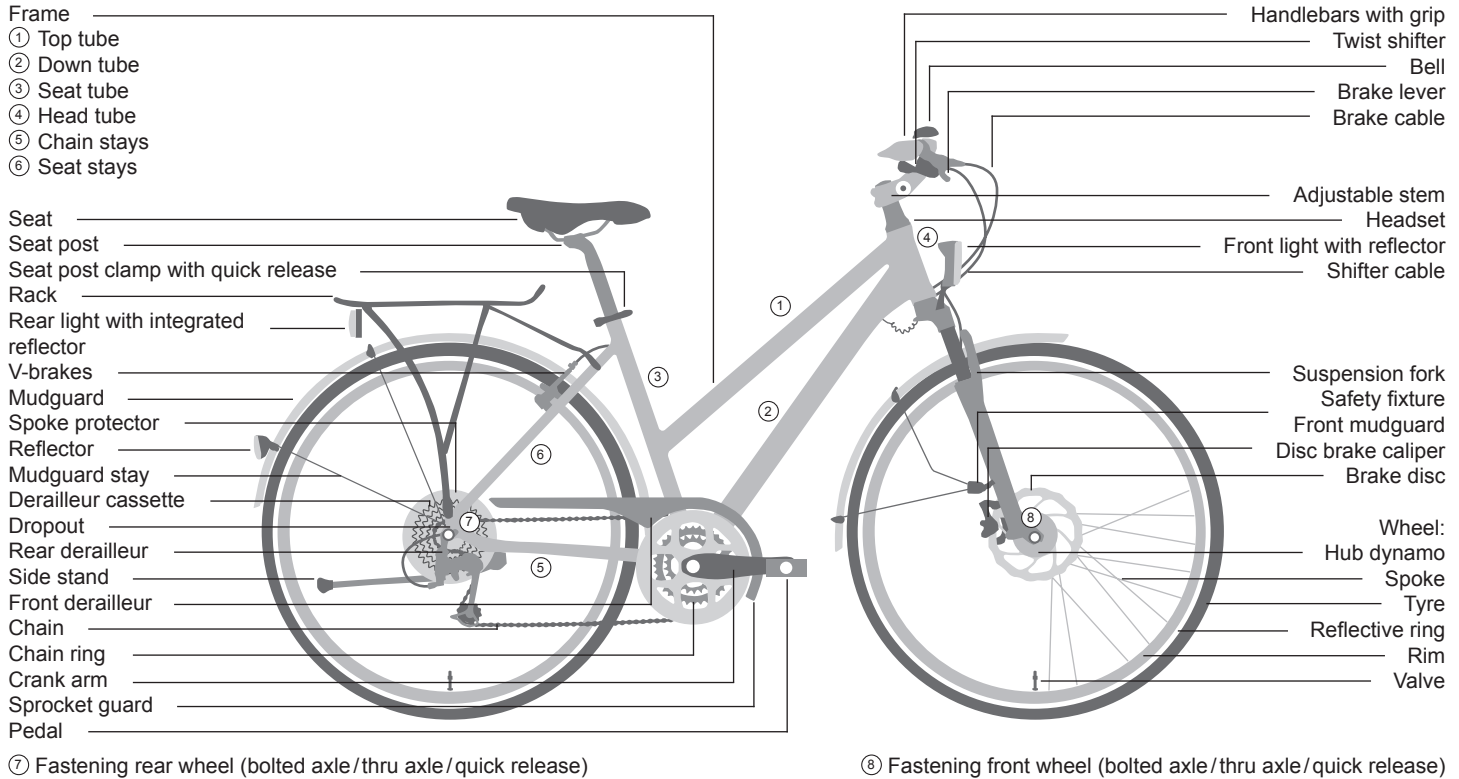

The City bike, Trekkingbike/ATB, Dutch-style bike, Single-speed bike/Fixie, Children's bike you purchased may look different. This operating manual only applies to the bicycle with which it was supplied. This instruction manual only applies to the bicycle mentioned on the envelope with which it was issued.

Bicycle parts/mountain bike

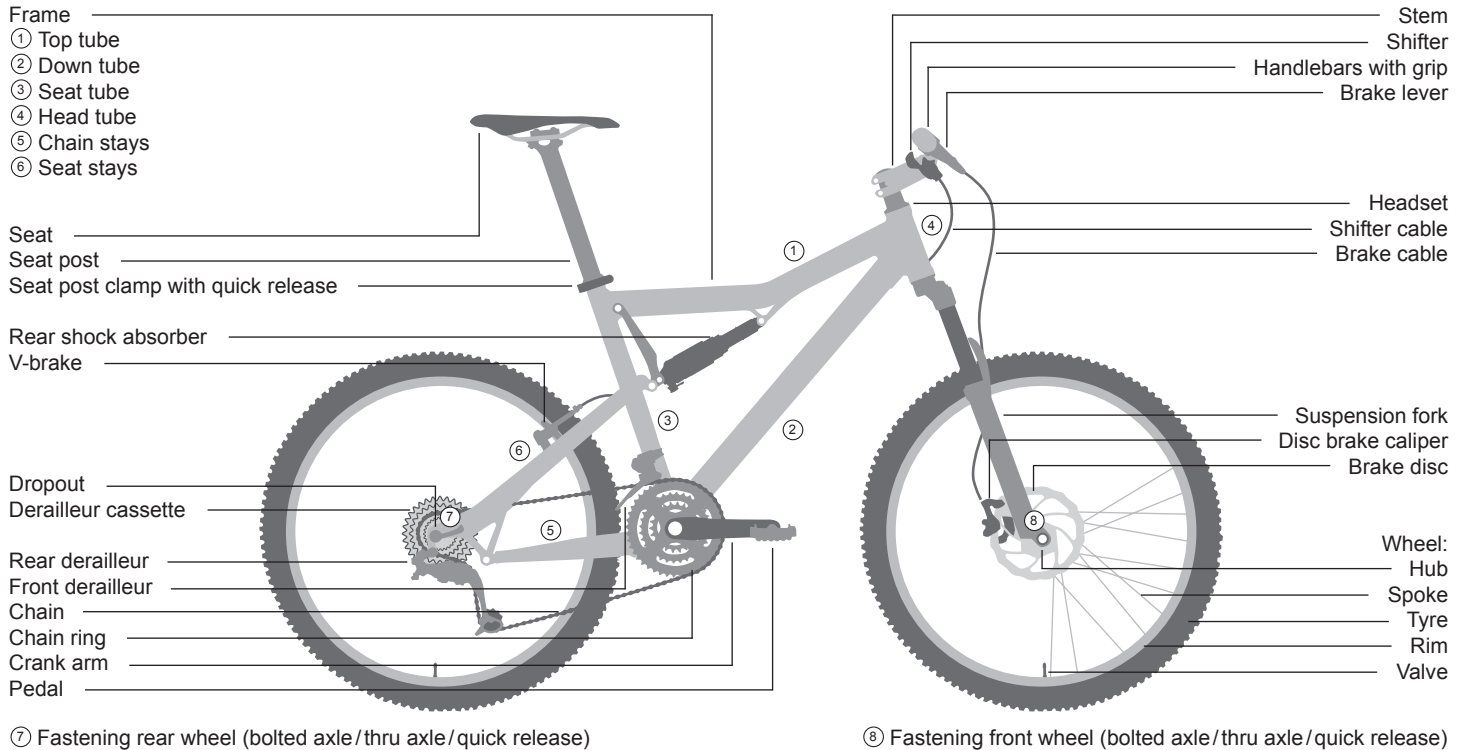

The Mountain bike, All Mountain, Enduro, Freeride/Downhill, Dirt/Street/Freestyle bike, Cross bike/ATB, Fatbike, Single-speed bike/Fixie, BMX you purchased may look different. This instruction manual only applies to the bicycle mentioned on the envelope with which it was issued.

Bicycle parts/road bike

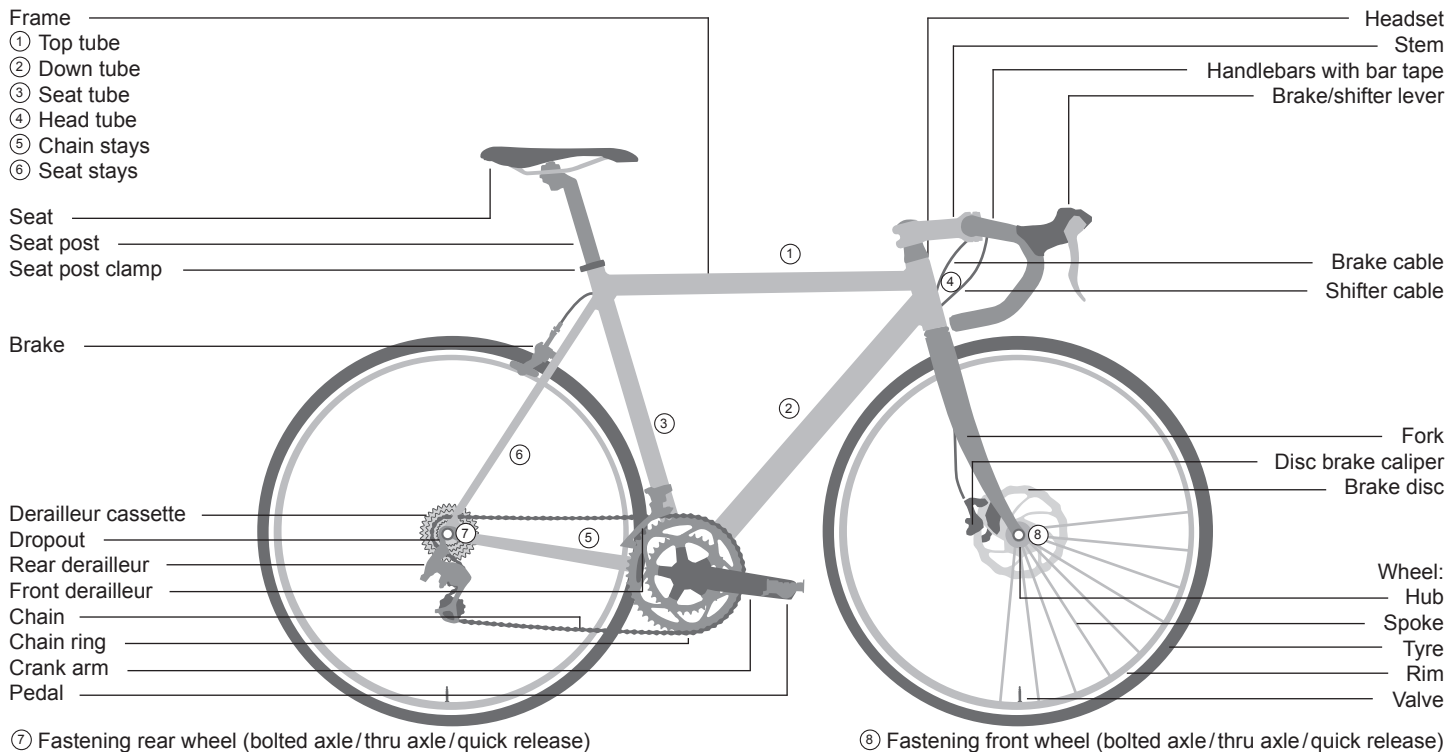

The Road Racing bike, Triathlon/Time trial bike, Cyclocross bike, Single-speed bike/Fixe you purchased may look different. This instruction manual only applies to the bicycle mentioned on the envelope with which it was issued.

Contents

Bicycle parts/city and touring bikes	A	Rims/tyres	23
Bicycle parts/mountain bike	B	Tyres and tyre pressure	24
Bicycle parts/road bike	C	Tubeless tyres	25
		Tubular tyres	25
Contents	1	Flat tyre repair for conventional tyres	25
Imprint	1	Brakes	27
Foreword	2	Gear system	31
Safety information	3	Inspection plan	33
For your safety	4	Lubrication	35
Before the first ride	4	Bolted connections	36
Before each ride	5	Loose accessories	37
If you have fallen	6	Loose luggage rack	37
Legal regulations	7	Bar ends	37
Intended use	7	Attached accessories	38
Adjusting the bicycle to the rider	10	Accessories/ maintenance/ spare parts	38
Using quick releases and through axles	10	Light system	38
Through axles	11	Mudguard	39
Installing pedals	13	Rack	40
Setting up the seating position	13	If you have purchased a time trial or triathlon bike	41
Setting up the angle of the seat	14	Triathlon/TT bike	41
Setting up the position of the handlebars/ stem	15	Disc wheels, special wheels	41
Setting up the brake levers	16	Electrical/electronic gear shifting system	41
Back pedal brakes	16	When you have purchased a BMX bicycle	42
Children	17	How to use carbon components	43
Children's bicycle / training wheels	17	Transporting the bicycle	44
Transporting children/child bike trailers	17	Liability for material defects (warranty)	45
Frame	19	Environmental protection tips	45
Suspension	19	Inspections	46
Maintenance / upkeep	21	Hand-over documentation	D
Chain	21	Bicycle identification	E
Belt drive	22	Notes / Guarantees	F
Wheels	23		

Imprint

For questions concerning your bicycle please always contact your dealer first, only then in case the manufacturer of the bicycle.

For contact details please refer to the warranty section, back cover or other included information of the brand/manufacturer.

Responsible for sales and marketing

inMotion mar.com
info@inmotionmar.com
www.inmotionmar.com

Content and images

Veidt-Anleitungen
info@veidt-anleitungen.de

Legal inspection by a lawyer's office specialising in intellectual property

These operating instructions cover the requirements and scope of EU law.

In the case of delivery or use of this product outside of the scope of the aforementioned area, the manufacturer of the bicycle is required to supply the necessary operating instructions.

© Multiplication, reprinting and translation as well as any commercial use (including extracts, in printed or digital form) is only permitted if specifically granted in writing in advance.

3in1 EN Version 5.1, November 2024

Foreword

Dear Customer,

to start with, we'd like to provide you with some important information about your new bicycle. This will help you make the most of its benefits and avoid any possible risks. Please read this instruction manual carefully and keep it for your future reference. Your bicycle has been handed over to you fully assembled and adjusted. If this is not the case, please contact your specialist retailer to ensure that this important work is completed or make sure you carefully read the enclosed assembly instructions and follow all the directions given.

It is assumed that users of this product have a basic and sufficient knowledge of how to use bicycles. Everyone that uses

- repairs or services
- cleans
- or disposes of

this bicycle has to understand and take note of the content and purpose of this operating manual. If you have any further questions or have not quite understood certain points, you should contact a specialist bicycle retailer for your own safety.

All information contained in this operating manual relates to the design, technology as well as care and maintenance of your bicycle. Please take note of this information, as much of it is relevant to safety. Failure to consider this information can cause accidents, falls and damage to property. As modern bicycle technology is highly complex, we have chosen to only describe the most important points.

For more specific technical details, please refer to the enclosed notes and instructions from the respective manufacturers of the individual components used. If you are unsure about a particular point, please contact your specialist retailer. Before riding your bicycle on public roads, you should inform yourself about the applicable national regulations in your specific country.

Firstly, here are a few important pointers as to the rider's person which are also very important:

- Always wear a suitable bicycle helmet adjusted to fit your head and wear it for every ride!
- Read the instructions supplied by your helmet manufacturer relating to fitting the helmet properly.
- Always wear bright clothing or sportswear with reflective elements when you ride. This is vital so that other people can SEE YOU.
- Always wear tight clothing on your lower body, and trouser clips if required. Your shoes should be grippy and have stiff soles.
- Never ride with your hands off the handlebars

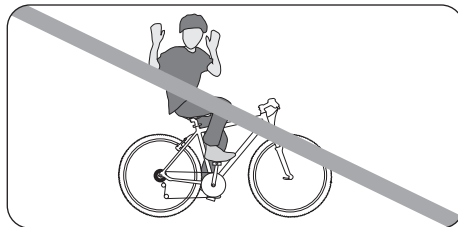

Even if you are an experienced bicycle user, please take the time to first read the chapter "Before the first ride" and then carry out all the important checks from the chapter "Before each ride"! Please note that as a bike rider, you are particularly at risk on public roads.

Ensure that you protect yourself and others with responsible and safe riding!

Note for parents and legal guardians:

As your child's legal guardian, you are responsible for your child's actions and safety. This includes responsibility for the technical condition of your child's bicycle and adjusting it to fit your child's body size.

Please read the "Children's bicycles" section for aspects which you and your child should always consider.

In addition, you should also ensure that your child has learnt how to use the bicycle safely. The child should know how to ride the bicycle properly and responsibly in the environment in which it will be used.

- Note that children under eight years of age have to ride on the pavement. Children between eight and ten years of age may use the pavement.
- Children must dismount from their bicycle when they have to cross a cycle lane.

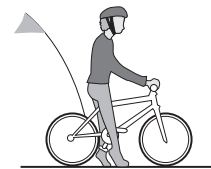



- **INGESTION HAZARD: DEATH** or serious injury can occur if ingested.
- A swallowed button cell or coin battery can cause **Internal Chemical Burns** in as little as **2 hours**.
- **KEEP** new and used batteries **OUT OF REACH OF CHILDREN**
- **Seek immediate medical attention** if a battery is suspected to be swallowed or inserted inside any part of the body.

Safety information

Please carefully read all warnings and notes in this operating manual before using the bicycle. We recommend keeping the manual close to your bicycle, so that it is always at hand.

Please read the sections “Intended use”, “Before the first ride” and “Before each ride” before riding your pedelec for the first time!

If you lend your bicycle to a third party, please give them this operating manual with the bicycle. This operating manual contains different types of pointers – one providing important information about your new bicycle and how to use it, a second referring to possible damage to property and the environment, and a third type warning against potential falls and serious damage, including physical injury. The fourth type of pointer asks you to comply with the correct torque in order to prevent components from coming loose or

breaking. If you see this symbol, there is always a risk that the danger described can occur! The text which the warning covers always has a grey background.

The warnings break down as follows:



Information: This symbol provides information about how to use the product or highlights specific parts of the operating manual that are particularly important.



Warning: This symbol is aimed at warning you against improper use that could result in damage to property or the environment.



Danger: This symbol indicates possible dangers to your health and life that could arise if specific actions are not taken or corresponding regulations adhered to.



Important bolted connection! Please adhere to the exact recommended torque when tightening this connection. The correct mounting torque is either displayed on the component or listed in the table of torques on page 36. A torque wrench has to be used to achieve the precise prescribed torque. If you don't own a torque wrench then you should always leave this work up to a specialist retailer! Parts which do not have the correct torque could fall off or break! This can result in serious accidents!

Check that all quick releases are safe and secure every time you ride after your bicycle was unused, even for a short period of time! Regularly check that all bolts and components are secure. Note that components made of composite materials, i.e. carbon fibre, often require a lower tightening torque. See page 36. Common parts made of carbon fibre include the handlebars, stems, seat posts and saddle rails, frames, forks, and cranks. Ask your specialist retailer to instruct you on how to properly use and maintain these materials.

These operating instructions are based on the assumption that you can ride a bicycle. These are not instructions to learn how to ride a bicycle. They are also not intended to provide information on how to assemble or repair the bicycle.

For your safety

Please be aware that riding a bicycle involves some basic risks. You, the bicycle rider, are exposed to particular risk. Always remain aware that you are not as protected as you are, for example, in a motorcar. You have no airbag and there is no car body. You are nevertheless moving faster and in other parts of the road than a pedestrian. You should therefore pay special attention to other road users.

Never use headphones or a mobile phone while riding a bicycle. Never ride when you are not able to keep full control. This applies, in particular, after taking medication or consuming alcohol or drugs.

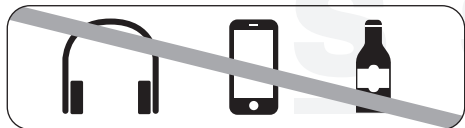

- Please adapt your riding style to the conditions when the road is wet or slippery. Ride more slowly and brake earlier, as the braking distance will be significantly increased.
- Adapt your speed to the terrain and your riding skills.
- Never ride with your hands off the handlebars.



Modern bicycle technology is high tech! Working on bicycle parts therefore requires special knowl-

edge, experience and specialist tools! Please do not attempt to work on the bicycle yourself! Give your bicycle to a specialist retailer for repair, servicing and maintenance!

Before the first ride

Please also consult the additional operating manuals of the individual component manufacturers, which were supplied with your bicycle or available online.

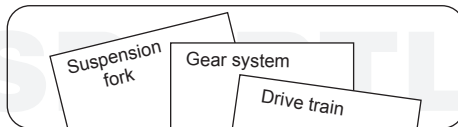

Your specialist bicycle retailer will be happy to answer any further questions you have after reading this manual.

Please ensure that your bicycle is ready for use and is adjusted to fit your body.

These include:

- Setting the position and fixture of the seat and handlebars
- Checking the assembly and settings of the brakes
- Securing the wheels into the frame and fork

To ensure that you enjoy a safe and comfortable riding position, please allow your specialist dealer to set up your handlebars and stem.

Adjust the seat to a safe and comfortable position for you (see page 13).

Allow your specialist retailer to set up the brakes so that the brake levers are always within easy reach. Ensure that you know which lever operates which brake (right/left)!

Usually, the right brake lever operates the rear wheel brake and the left brake lever operates the front wheel brake. Despite this, however, you should still check if the same rule applies to your bike's levers before riding it for the first time, as this can sometimes vary.



Modern braking systems might be more powerful or have a different functionality than those that you are used to. Please get to know the brakes on a safe piece of land before setting off on your first ride with the bicycle!

If you use a bicycle with carbon fibre rims, please note that this material provides a significantly weaker braking effect in combination with rim brakes than aluminium rims do! Also remember that the effectiveness of brakes can be different, often worse, than you are used to in wet conditions or on slippery surfaces. Please take the possibility of longer braking distances and slippery surfaces into account when riding!

If you are riding a single speed or a "fixie", please familiarise yourself with its behaviour under braking before your first ride! Single speed wheels with just one brake are not permitted on public roads. Fixie bicycles cannot freewheel, which means that the pedals ALWAYS turn with bicycle's wheels.



Get familiar with the grip of your bicycle pedals when they have a rubber or plastic cage. Rubber and plastic pedals become very slippery under wet conditions!

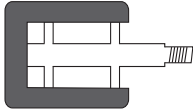

Snagging hazard

Moving and turning parts of your bike may lead to danger during use, maintenance and upkeep.

Protect yourself by not wearing loose clothes that may get caught. During use, maintenance and upkeep, stay away from turning parts (wheels, brake discs, cassettes). Do not touch moving, sharp or protruding parts (chains, pedals).

Ensure that the wheels are securely fastened in the frame and fork. Check that all quick release skewers, through axles and all important nuts and bolts are secure (see page 10 and 36).

Lift your bicycle up slightly and drop it onto the ground from about 10 cm in the air. If it rattles or makes another unusual noise, ask a specialist retailer to identify and fix the problem before you ride.

Push the wheels forwards with the brakes applied. The back brake should completely prevent the back wheel from moving, while the front brake should lift the back wheel off the ground with its braking effect. Please take an initial test ride in a safe place where you can familiarise yourself with the new brakes! Modern brakes can behave completely differently under braking than those that you are perhaps used to. The bicycle's steering should not rattle under braking or exhibit any play.

Check the air pressure in the tyres. You will find instructions as to the correct tyre pressures on the sides of the tyres. Please adhere to the required minimum and maximum pressure! If you cannot find any recommended pressures, 2.5 bar/36 psi is a suitable pressure for most tyres. If the wheels are thinner than 30 mm or 1 1/8", the tyre pressure should be filled to 4 bar/58 psi.

As a general rule of thumb when you are out on a ride, you can check the tyre pressure by doing the following: If you place your thumb on a pumped up tyre, you should not be able to significantly change its shape by applying pressure. Check the tyres and rims. Scan them for any damage, cracks or deformations, as well as embedded particles, e.g. shards of glass or sharp stones.

If you should find any cuts, rips or holes, please refrain from riding! First have your bicycle checked over by a specialist.

Before each ride

Before every ride, please check that:

- The lights and bell are working and safely secured
- The brakes are working safely and are properly secured
- The cables and fittings are not leaking if you have a model with hydraulic brakes
- The tyres are free of foreign objects and damage, and the rims are not damaged and run true,
- particularly after riding off road
- The tyres have a sufficient tread depth
- The suspension components are working properly and are safely secured
- The screws, nuts, through axles and quick releases are firmly placed (see page 10 and 36).
- There are no deformations or cracks on the frame and fork.
- The handlebars, stem, seat post and seat are both correctly and securely fastened as well as set up in the right position
- The seat post and seat are secure. Try turning the seat or tipping it upwards or downwards. It should not move.
- If you are using clipless/magnet pedals, please check that they are working properly. The pedals should release easily and smoothly.
- For BMX bicycles: Safe operation of the rotor, safe attachment of the handlebars to the stem and of the axle pegs.



If you are unsure of whether your bicycle is in a sound technical condition, take it to a specialist retailer to be checked instead of riding it!

It is particularly important if you use your bicycle a lot, either through sports riding or daily use, that you regularly have all the important parts checked by a specialist retailer. Frame and fork, suspension components and other parts relevant to your safety such as brakes and wheels are subject to heavy wear, which can impact the operating safety of these parts.

If you use parts for longer than their intended lifetime, these can fail without warning, which can in turn lead to falls and serious injury!



Please make these checks before continuing after a fall or if your bicycle falls over!

Aluminium parts cannot be safely bent back into shape, while carbon components can sustain damage which is not recognisable to the eye.

Allow the bike to be checked by a specialist retailer.

If you have fallen

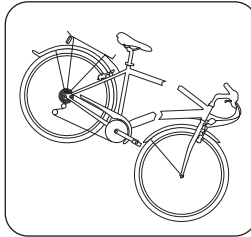

Check the entire bicycle for damage. It could have dents and cracks in the frame and the fork as well as bent components. When parts of the handlebars or the seat were shifted

or twisted, the respective parts must be checked for functionality and safe attachment.

- Look carefully at the frame and the fork. Deformation can usually be seen quite clearly when you look at the surface from different angles.
- Look whether the seat, seat post, stem or handlebars are still in their correct position. Do NOT twist or bend the component from its changed position without opening the respective screw connection. It is essential that you adhere to the fastening torque prescribed when fastening the components. The appropriate information can be found on page 36 and in the Chapter "Quick release", page 10.
- Check whether both wheels are correctly and securely attached to the frame and the fork.
- Lift the front wheel and turn it and then lift the rear wheel and turn it. The rim must run straight and centrally through the brakes. The tyre may not touch the brakes. The distance between the frame or the fork and the tyre indicates whether a wheel runs in a central position in bicycles with disk brakes.

- Test whether both brakes have full functionality.
- Do not start riding before checking whether the chain is safely resting on the chain wheel and the sprocket. It must run fully over the gear wheels. Falls and serious injuries may result if you start off and the chain falls off a gear wheel.



Aluminum components may break suddenly if they have become deformed. Do not use deformed or bent components, e.g. after a fall. Always exchange such components.

Components made of carbon can be severely damaged without showing any damage. Have all components made of carbon checked by a specialist dealer after a fall.

Do NOT ride on when you notice that something on your bicycle has changed. Check loose parts for functionality and always use a torque spanner to fasten them. Bring your bicycle to a specialist dealer, describe the fall and have the bicycle inspected!

Legal regulations

Before riding your bicycle on public roads, you should inform yourself about the applicable national regulations in your specific country.

This section provides information on how the bicycle has to be equipped to be permitted to participate in public road traffic.

Here you can find out which light systems have to be installed or carried with you and which brakes the bicycle has to be equipped with.

There is also an explanation of which age restrictions apply and what age riders have to be to ride where. The participation of children in public road traffic is also addressed here. If there is an obligation to wear a helmet, it is stated here.



Intended use



Bicycles are intended for transporting one person at a time. Transporting an additional person on the bike is only permitted in the framework of national legislation. A tandem is exempt from this. If you would like to transport baggage, this requires that your bicycle is fitted with suitable equipment. Children can only be transported in children's seats or trailers intended for this purpose. We recommend not taking any chances when it comes to quality in this area!

Ensure that you do not exceed the maximum permissible weight.



Permitted overall weight: Rider's weight + Bicycle weight + Baggage weight (see page D).

The information in these operating instructions only applies to bicycle types that are listed on the cover. Information concerning individual bicycle types is marked appropriately.

Appropriate use includes adherence to the operating, maintenance and repair conditions that are described in these operating instructions.



Dangers of improper use

Only use your bike for its intended use. Read the section "Intended Use".

This also includes adherence to the operating, servicing and maintenance conditions that are described in this manual.

Inform other users of the intended use and the dangers of not adhering to it.

Improper use, overloading and lack of maintenance may lead to accidents and falls involving severe injuries to you and other people!

The components have been solely designed and approved for use in bicycles without electrical assistance. They should not be used for any other purpose. They can only be used in competitions or for commercial purposes with the express permission of the manufacturer.



Example sticker

There may be a sticker on your bicycle that shows you what you can use your bicycle for.

Your bicycle must be equipped in accordance with the applicable national regulations in order for it to be used in the way indicated by this sticker.

Always read and comply with the conditions of use for your bicycle type:



Type 1 includes city and touring bicycles and can be used on normal and paved surfaces. The typical speed should be between 15 and 25km/h. The tires should stay in contact with the ground at all times. They can occasionally be used to ride up and down small drops of 15cm max.

(e.g. curbs) as long as this is done carefully.

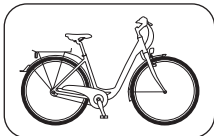

These bicycles are intended for use for commuting and recreational rides with moderate exertion.

Manufacturers and dealers are not liable for any use outside of the conditions of use for Type 1 bicycles. This particularly applies to damage resulting from a failure to comply with the safety instructions, such as:

- off-road use;
- improper use;
- overloading;
- the improper repair of defects.

Type 1 bicycles are not designed to withstand extreme use, i.e. riding down stairs or on jumps, performing tricks/stunts or racing in official competitions. Participation in competitions is only allowed when authorised by the manufacturer.

Type 2 includes ATBs, trekking, cyclo-cross and gravel bicycles.



The conditions of use for type 1 bicycles apply. In addition, these bicycles can be used on unpaved or gravel roads. They can also be used on routes with moderate elevations and gradients. The typical speed should be between 15 and 25km/h. The tires may repeatedly lose contact with the ground

when riding on uneven terrain. They can be used for drops or jumps up to 15cm high.

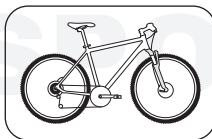

These bicycles are designed for recreational rides and trekking under moderate strain.

Manufacturers and dealers are not liable for any use outside of the conditions of use for type 2 bicycles. This particularly applies to damage resulting from a failure to comply with the safety instructions, such as:

- off-road use;
- improper use;
- overloading;
- the improper repair of defects.

Type 2 bicycles are not designed to withstand extreme use, i.e. riding down stairs or on jumps, performing tricks/stunts or racing in official competitions. Participation in competitions is only allowed when authorised by the manufacturer.

Type 3 includes MTBs with a suspension travel of up to 120mm or BMX bikes.



The conditions of use for bicycle types 1 and 2 apply. In addition, these bicycles can be used on nearly impassable paths, challenging terrain or undeveloped paths. Type 3 bicycles can be used on drops and jumps of 60 cm max. They can also be used to ride over obstacles such as roots, stones or steps. If

you are unsure, stop when driving off-road and check the height of these obstacles.

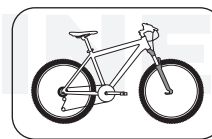

This bicycle has been designed for use in sporting and competitive events with moderately technical routes.

Sufficient experience and technical skills are required to ride the bicycle safely on challenging terrain.

Manufacturers and dealers are not liable for any use outside of the conditions of use for type 3 bicycles. This particularly applies to damage resulting from a failure to comply with the safety instructions, such as damage caused by:

- using the bicycle on challenging terrain, for high jumps, steep inclines, downhill and in bicycle parks;
- improper use;
- overloading;
- the improper repair of defects.

Type 3 bicycles are not designed to withstand extreme use, such as going off high jumps or performing tricks or stunts. Participation in competitions is only allowed when authorised by the manufacturer.

Type 4 includes all-mountain, trail and enduro bicycles.



The conditions of use for bicycle types 1, 2 and 3 apply. In addition, these bicycles can be used on descents on unpaved paths at speeds of up to 40 km/h. Type 4 bicycles can be used on jumps of 120cm max. They can also be used to ride over obstacles such as roots, stones, steps or small ramps. If you

are unsure, stop when driving off-road and check the height of these obstacles.

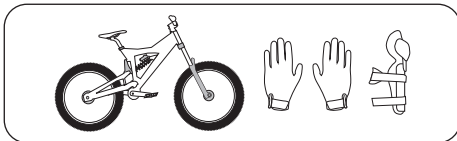

This bicycle has been designed for use in sporting and competitive events with very technically challenging routes.

Sufficient experience, technical skills and a good command of the bicycle are required to ride it safely on challenging terrain.

Manufacturers and dealers are not liable for any use outside of the conditions of use for type 4 bicycles. This particularly applies to damage resulting from a failure to comply with the safety instructions, such as:

- using the bicycle on difficult terrain, for high jumps, extreme downhill use or aggressive use in bicycle parks;
- improper use;
- overloading;
- the improper repair of defects.

Type 4 bicycles are not designed to withstand extreme strain, such as complicated tricks or stunts.

Type 5 includes freeride, downhill and dirt-jump bicycles.



The conditions of use for bicycle types 1, 2, 3 and 4 apply. In addition, these bicycles can be used on unpaved paths with extreme jumps and downhill sections. They can also be used on extreme jumps that are over 120 cm high. Speeds of over 40 km/h can be reached on downhill sections and jumps. They

can also be used to ride over obstacles such as roots, stones, steps or ramps.

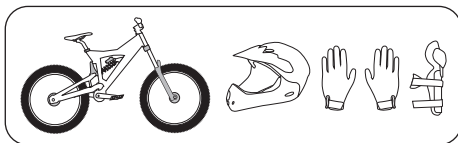

These bicycles have been designed for use in extreme sports.

The conditions of use described require the rider to have excellent technical skills, extensive experience and an outstanding command of the bicycle.

Manufacturers and dealers are not liable for any use outside of the conditions of use for type 5 bicycles. This particularly applies to damage resulting from a failure to comply with the safety instructions, such as:

- improper use;
- overloading;
- the improper repair of defects.

Type 6 includes racing, triathlon and TT bicycles.



The conditions of use for type 1 bicycles apply. In addition, their typical speed is between 30 and 55 km/h. In competitions or on other occasions, top speeds of over 50 km/h may be reached, e.g. during sprints or descents.

These bicycles are designed for use in sporting and competitive events with high exertion.

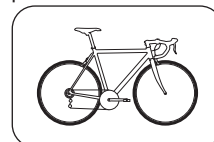

The conditions of use described require the rider to have sufficient expertise and technical skills.

Manufacturers and dealers are not liable for any use outside of the con-

ditions of use for type 6 bicycles. This particularly applies to damage resulting from a failure to comply with the safety instructions, such as:

- off-road use;
- improper use;
- overloading;
- the improper repair of defects.

Type 6 bicycles are not designed for extreme strain, such as riding down stairs or on jumps or performing tricks or stunts.



If you are not sure what type of bicycle you have, ask your specialist bicycle retailer or the manufacturer about its intended uses. Before riding your bicycle on public roads, familiarise yourself with the regulations that are applicable in your country. Only ride on routes where vehicles are permitted. Specific national or regional regulations may apply.

Adjusting the bicycle to the rider

The seat post, seat, stem and handlebars can only be tightened and secured with quick releases or bolted connections.



For detailed information, please read the instructions supplied by the manufacturer. The functionality and secure fit of the suspension parts are vital for your safety!

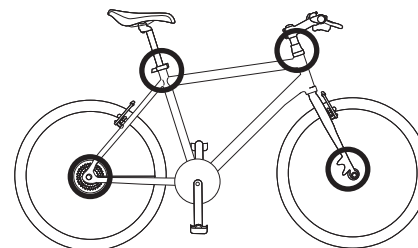

Possible positions of quick releases / through axles



If your bicycle has one or several full floating axles, please read the corresponding instructions provided by the component manufacturer on how to operate and service these parts.

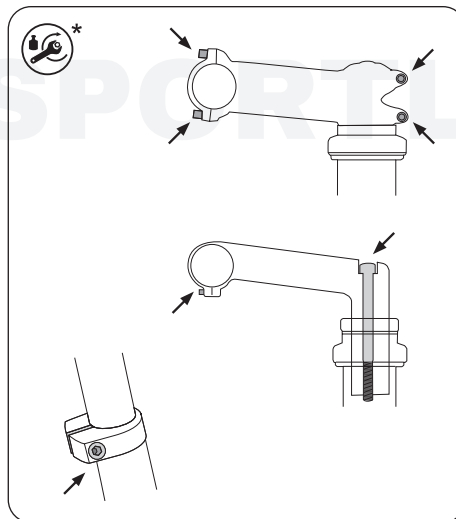

Possible positions for adjusting bolted connections

Using quick releases and through axles

Quick releases and through axles are systems installed on the bicycle in place of bolted connections. They consist of two parts: The clamping lever, which provides the necessary clamping force, and the locking nut, which allows you to regulate the clamping force. You can change the setup of your quick release when the clamping lever is open.



The quick release closes with the correct holding force when counter-pressure is visible at the centre of the lever movement and the force of the ball of your thumb is required to close the lever completely.

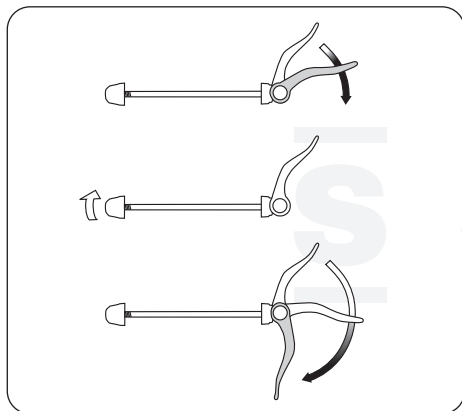

Loosening adjusting nuts

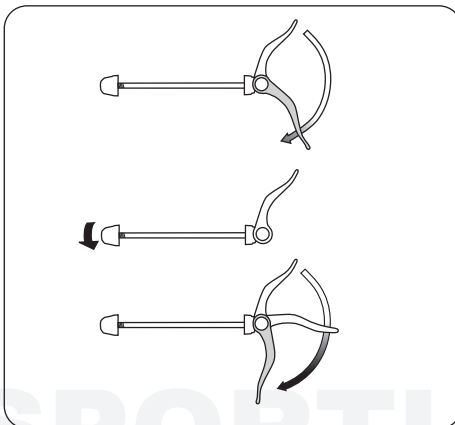

Tightening adjustment nuts



- All quick releases must be firmly closed before you ride off.
- Make sure that all quick releases and through axles are properly in place even if the bike was only left unattended for a short period of time.
- The quick release lever must be close to the frame, fork or seat post when it is closed!
- The tip of the quick release lever must always point towards the back when it is closed. This ensures that it cannot open due to contact during the ride.



- The quick release lever for the wheel has to be installed on the opposite side to the brake disk, otherwise you could suffer burns from the brake disk. The clamping force of the quick release can also be reduced if it is heated by the brake disk.



Please lock down wheels and other parts that are attached with quick releases when you park your bicycle.

Through axles



If your bicycle has one or several through axles, please read the corresponding instructions provided by the component manufacturer on how to operate and service these parts.

Through axles that mostly function – and must be handled – like quick releases, are also currently used in chassis in lieu of bolts.

Mostly the through axle is screwed into the dropout on the side opposite the drive and then presses the two parts of the fork against the hub located between them. The hub and the axle are fastened with a quick-release lever.

Systems in which the axle is only inserted or screwed in and then fastened with a screw also exist. Refer to the attached component manufacturer instructions and allow your dealer to explain the system to you in detail.

The following instructions refer particularly to the quick-release axles of the Rockshox forks, but are also generally applicable to other forks.



Inappropriately installed wheels may shift while you are driving or detach from the vehicle. This may damage the vehicle and expose the driver to severe and life-threatening injuries. It is therefore important to take note of the following instructions:

- Ensure that the axle dropout and quick-release mechanisms are clean and free of dirt and impurities.
- Let your dealer explain in detail how your front wheel is correctly fastened using the quick-release system installed.
- Appropriately fasten the front wheel.
- Never use the bicycle unless you are sure that the wheel has been properly secured and cannot come loose.

Mounting

Place your wheel into the dropout below the fork leg. The hub must be firmly attached in the dropout.

Disc brakes: Ensure that the brake disk is properly inserted into the brake calliper. Ensure that neither the brake disk nor the hub or the brake disk fastening screws knock against the lower parts of the fork. If you do not know how to adjust disc brakes, please read the instructions provided by your disk manufacturer.

Inserting and fastening

1. Turn the quick-release lever to the open position. Ensure that the lever grips the appropriate slot in the axle.
2. Push the axle from the right side into the hub until it connects to the thread of the left dropout

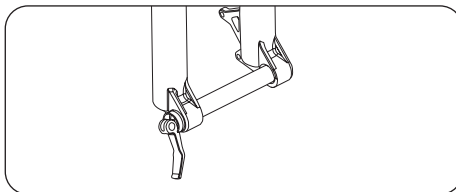

Quick-release axle in the fork dropouts, without hub, Rock Shox® fork

3. Fasten the axle in the dropout by placing the fast-release lever into the axle flange and fastening the axle in a clockwise direction until it is hand-tight. Close the quick-release lever by folding it over.

During the closing movement, you should feel tension when the quick-release lever is in the horizontal position (90 degrees to the lower part of the fork / axle extension).

The quick-release lever should leave a clear imprint on your palm.

In case you do not feel resistance in the 90-degree position and the lever does not leave a clear imprint on your hand, the tension is not sufficient. Increase the tension as follows: Open the fast-release lever and slowly tighten the quick-release fastening screw until the correct tension has been achieved. In order to increase the tension, open the fast release lever and insert a 2.5 mm

Allen key into the tension adjuster in the middle of the lever tappet.

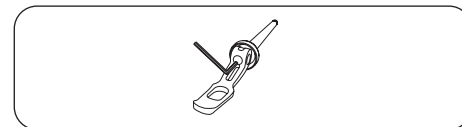

Trough axle with allen key for adjustment

Again turn the Allen key in a clockwise direction and again check the lever tension. Repeat the process until the lever tension is sufficient.

Do not use any other tools to fasten the axle to the lower part of the fork. The axle and/or the lower part of the fork may be damaged when the axle is excessively tightened.



The quick-release fastener may not be readjusted or turned after closing. Turning the quick-release fastener may loosen the axle and have a detrimental effect on driving safety. This may lead to severe or lethal injuries.

Removal

1. Open the quick-release lever and place it into the slot in the axle flange.
2. Turn the quick-release lever in an anti-clockwise direction until the axle exits from the thread of the dropout and then pull the axle out of the hub.

The basic function is the same when your bicycle is equipped with a Fox fork. The quick-release axle is then inserted into the fork from the left side.

Through axles of other manufacturers

Through axles of other manufacturers can be tightened differently. One possible way is to loosen the locknut in the dropout and to fix it after having turned it clockwise.

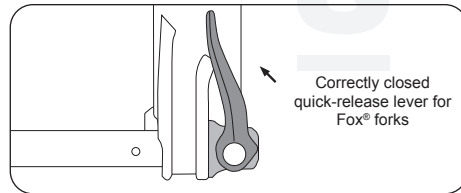
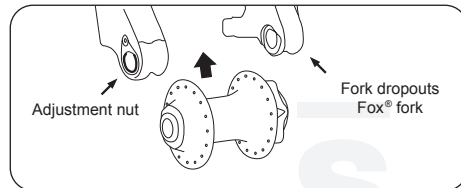

Check that all quick-release fasteners and quick-release axles are firmly attached, even when your bicycle only remained unsupervised for a short time. You may only start driving when all quick-release fasteners are firmly closed.

Installing pedals

If your bicycle was supplied without the pedals pre-installed, these have to be attached with the correct wrench. Please note that the pedals have to be screwed in in different directions and secured with a high mounting torque (see page 36). Apply assembly grease to both threads.

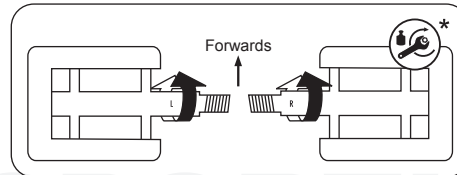

Please read the enclosed instructions from the respective manufacturer if you use pedals with hook or strap systems. Practice taking your feet in and out of the hooks and operating the strap releases in a safe place. Tightened straps do **NOT** release the feet! Possible consequences are falling and injuries.

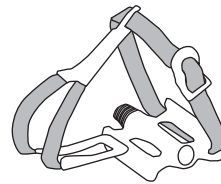

Ensure that you read the manufacturer's instructions before using magnet or clipless pedals. Practice clipping your shoes in and out of the pedals' locking system before your first ride in a quiet, safe place. Clipless pedals which do not properly release are a safety hazard.

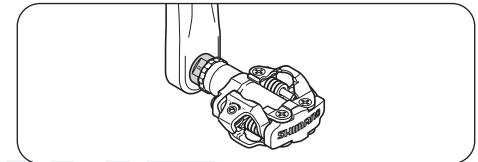

Source: Shimano® techdocs



In the case of magnet pedals, you are able to adjust how much force is required to release the shoe from the pedal. Please test this on your first ride with a setting that releases very easily! Regularly clean your magnet pedals and keep them in good condition with a suitable spray lubricant.

Setting up the seating position

Before you use your bicycle for the first time, the seating position has to be set up to suit your body size. This is vital for riding safely and securely. To do this, the seat's height, alignment and angle have to be set up, as do the height and alignment of the handlebars with the stem.

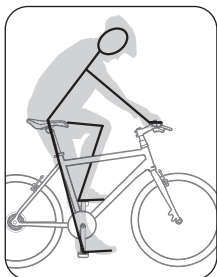

Correct seat height

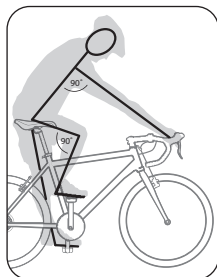

Knee angle of the upper leg
min. 90°, arm angle 90°

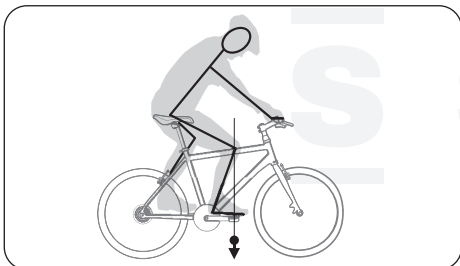

The knee must be above the axle of the front pedal

Determining the correct seat height

Set the seat to the height you estimate as correct. Sit on the bicycle. Allow somebody to aid you in doing this or lean against a wall or railing. Place one pedal to its lowest position and put your heel onto it. Your leg should now be straight. If you put your foot into the correct riding position, your leg should be slightly bent.

Your foot is in the correct position for starting off when its widest part is above the pedal axis.

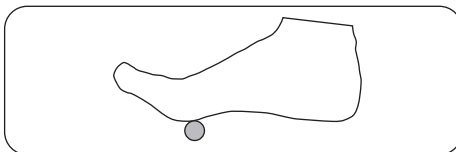

When you ride with clipless pedals, the pedal plates should be set to ensure this position. This prevents damage to your musculoskeletal system and ensures maximum transmission of force.



Children and people who do not feel secure when riding a bicycle should be able to reach the floor with the tip of their foot. They are otherwise at risk of falling and serious injuries.

Setting up the angle of the seat

When you have set the height of the seat, you have to check that the angle of the seat is suitable. The surface of the saddle should always be approximately parallel to the ground. You can adjust this by loosening the clamping bolts in the seat post.

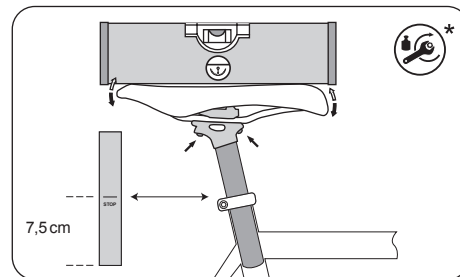

Patented seat post with two-screw locking mechanism

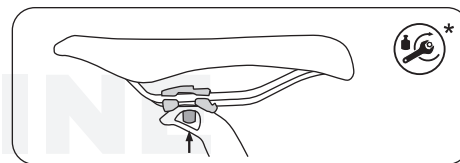

Patented seat post with one-screw attachment

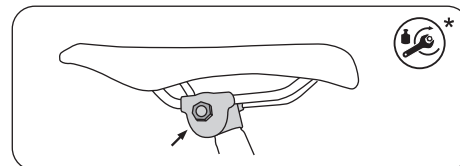

Attachment with seat clamps

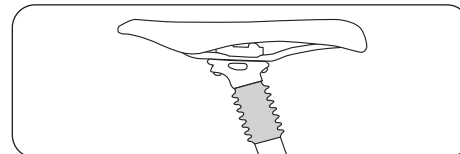

Suspension seat posts

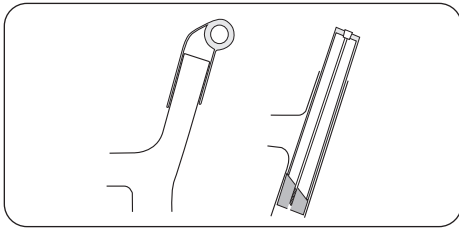

Integrated Seatpost

If your bicycle is equipped with a so-called integrated fixture: or operation and adjustment please read the enclosed instructions from the respective manufacturer.



Before you start riding, please test to see if your seat post and seat are secure. To do this, grab the seat at the front and back and attempt to turn it. It should not move.

If your mountain bike is equipped with a telescopic seat post, please ensure you read the instructions provided by the manufacturer before use.

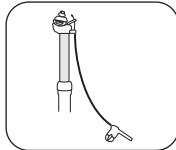

Please ensure that you read the part manufacturer's operating manual when setting up and operating suspension seat posts telescopic seat posts.



When adjusting the height of the seat, never pull the seat post further out than the maximum extension length marked! If your tube does not have a maximum marking, then you must leave a minimum insertion length of 7.5 cm.

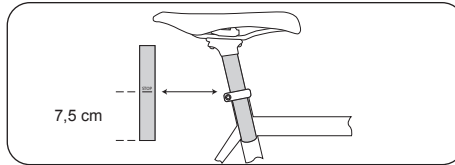

The minimum saddle height should be adjusted according to the rider's individual body size. He should be able to cycle without it interfering with his health or safety.

The seat post's maximum extension should allow it to remain securely clamped into place by the bolt. Ask your specialist retailer for advice on these last two points.

For bikes with rear suspension, the seat post should never come in contact with any part of the rear suspension.

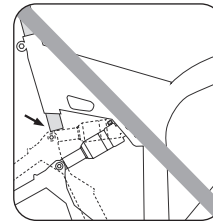
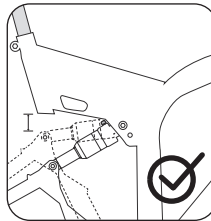

Setting up the position of the handlebars/stem

Various types of stem are used on bicycles:

Threadless stem

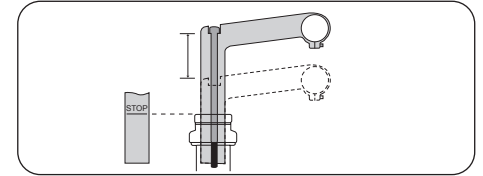

Height adjustment is possible



Changing the position of the stem also changes the position of the handlebars. You should always be able to safely reach and use grips and controls. Please ensure that all cables and lines are long enough to allow you to turn the handlebars in every possible way.

Adjustable stem

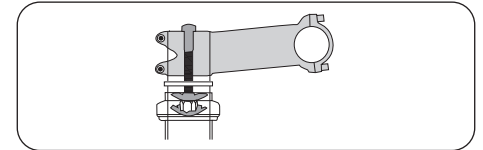

Height changes are possible by:

- Exchanging the spacer installed below or above the stem
- Turning the stem
- Exchanging the stem

Quill stem

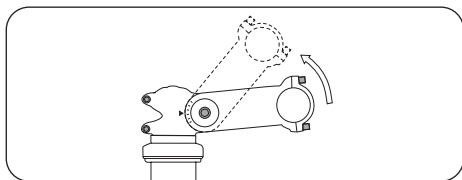

Adjustment of the stem incline is possible



For detailed information, please read the instructions supplied by the manufacturer. The functionality and secure fit of the suspension parts are vital for your safety!



BMX bicycles are ridden in a standing position. Please ask your specialised dealer which riding position is suitable for you.

Setting up the brake levers

Set the brake lever so that you can safely grip it and brake without getting tired. Familiarize yourself with the allocation of the brake levers to the rear and the front wheel brake! Some brakes are equipped with brake force limiters ("modulators"). These components are intended to prevent over-braking and dangerous blocking of the wheels.



When using power modulators, the braking force can increase sharply if you squeeze the brake levers hard or all the way to the end of their leverage. Please familiarise yourself with this new braking behaviour. Ensure that you receive and read the manufacturer's operating manual.



The brake levers should be set up so that your hands can safely and comfortably apply them as a straight extension of your arms.

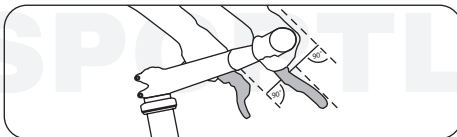

Check the position of the brake levers before your first ride. In hub gear systems, the right brake lever on the handlebars is generally the front brake. However, in chain gear systems, this brake lever is located on the left side of the handlebars. If you would like to swap the position of the brake levers on the handlebars, please contact a specialist retailer to do the work.

In order to allow people with smaller hands to safely apply the brakes, the levers can be set up to be closer to the handlebars using an adjusting screw (located in the lever).

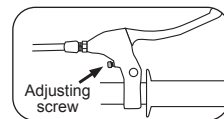

Set up the cable tension in such a way that the brake levers do not touch the handlebar grip, even when they are applied to their full extent!

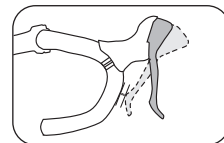
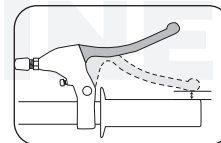
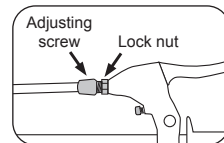

Mechanical brakes can usually be readjusted by turning the adjustment screw located on the handle. Loosen the adjustment screw from the handle until the braking function becomes more secure. Secure the adjustment by tightening the locknut on the handle.

Back pedal brakes

If your bicycle is equipped with back pedal brakes, you brake by pushing the pedals backwards instead of forwards. This means that your bicycle will not freewheel and you are unable to rotate the pedals backwards freely as you otherwise can!



The safest way to brake using back pedal brakes is when the line of the pedals is horizontal. If one pedal is at the top and one at the bottom, the poor force output produced is not conducive to effective braking!



The effectiveness of back pedal brakes can deteriorate substantially on long inclines! This type of braking system can become very hot from continuous braking. You should also use the front brake to slow down on long inclines. Try to give back pedal brakes the chance to cool down and do not touch them.

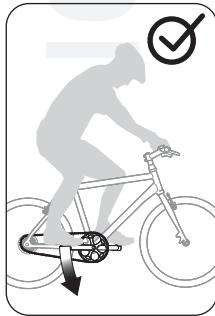
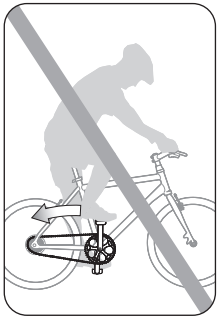

Children

Children's bicycle / training wheels

As a parent or legal guardian, you have a major responsibility when your child rides a bicycle and therefore wants to ride on public roads!

- Take the time to accompany the child on its first ride in a safe and quiet place (car park, field).
- Explain to the child that it should only ride with a helmet and easily visible, bright clothing.
- Set up the seat and handlebars so that the child is able to put its feet on the ground in unsafe situations – it is important to have a relaxed seating position if your child is to control the bicycle properly.
- Explain and practice using the front and rear brakes. It is especially important to practice using the backpedal brake and learning how to carefully apply the handbrakes connected to the front wheel.

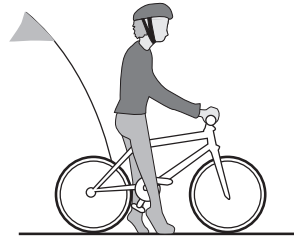

If you are using stabilisers, please make sure that you carefully read the manufacturer's assembly instructions! The stabilisers have to be absolutely secure, as your child is relying on their support! If they are not sure whether you have correctly assembled the stabilisers, please ask a specialist retailer for advice!



Using stabilisers can help a child get used to riding a bicycle. It avoids falls and helps children to feel safer. However, first the child gets used to riding with this "tricycle" style bike. It doesn't learn to keep its balance and make the necessary countermovements. That is why you have to be particularly careful when you first remove the stabilisers. This is very unfamiliar for the child and it first has to learn this new skill.

Transporting children/child bike trailers

- Please only use safe, certified children's seats!
- The child has to wear a helmet, its feet have to be away and protected from any possible contact with moving parts, such as spokes.
- A child seat changes the way your bicycle behaves when riding. Take note of the longer braking distances and the more unstable steering. Practice riding with a child seat in a safe area before taking to public roads.
- Please comply with the manufacturer's instructions supplied with the seat.



Only install children's seats on bicycles which are suitable for this kind of equipment.

Carbon fibre frames and components are not permitted to carry children's seats! Never attach a children's seat to the seat post! Wrap and protect all suspension and moving parts on the seat and seat post. Please ensure that your child cannot trap its fingers anywhere! This would result in a substantial chance of injury!

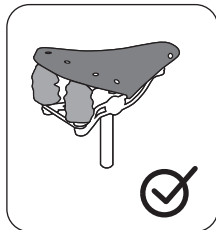
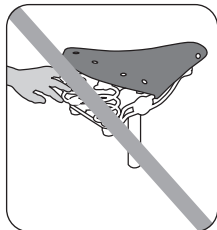
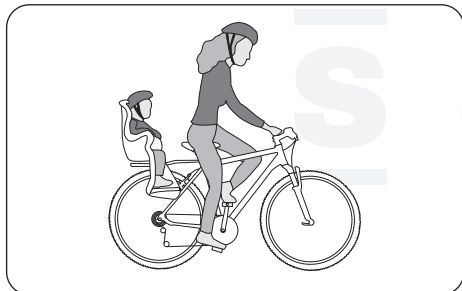

Find out about the legal regulations which relate to the age of the child and the rider.



If additional equipment was delivered with your bicycle, which was not pre-assembled, please ensure that you read the manufacturer's instructions.

Regarding child bike trailers:

- We recommend not taking any chances when it comes to the quality of child bike trailers!
- Only install children's trailers on bicycles which are suitable for this kind of equipment.
- A child bike trailer is easily overlooked in road traffic. Use colorful flags and permitted lighting to ensure that it becomes more visible. Ask your specialist dealer for safety accessories.
- Take note that with a trailer your vehicle is much longer than you are used to. A bicycle with trailer also behaves differently in bends than one without a trailer. You have to get used to that when moving in road traffic. First try with an empty trailer in safe, traffic-free terrain before you participate in road traffic.



Check whether the trailer manufacturers specify a permitted maximum payload and speed. These values must be adhered to. Children under 16 years of age are legally not permitted to ride a bicycle with a trailer.



Full suspension bicycles are not suitable for use with trailers and child bike trailers!

The bearings and attachments are not designed to withstand this sort of force. This could result in strong wear and breaks with serious consequences.

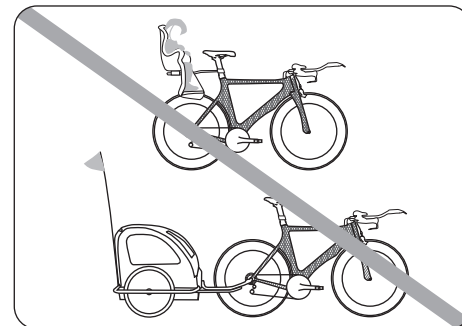
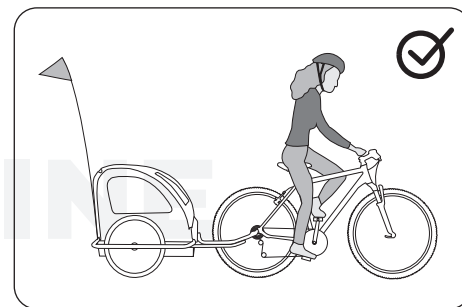

Frame

Frame shapes vary according to the type and function of the bicycle. Modern frames are made of various materials, such as steel, aluminium alloys or carbon (carbon fibre).

Thanks to the evolution in materials and construction techniques, it is nowadays possible to produce all shapes of frames safely so they perform stably during riding. So despite a low step-through, you can still be sure that your bicycle is always safe on the roads, even with luggage on board.



If your bicycle is stolen, it can be identified using its frame number. Please always note down the full number in the correct order. Otherwise it is impossible to make a unique identification. In the documentation you received from the retailer when you purchased your bicycle, there is also a section where the frame number is entered. The frame number can also be engraved on various parts of the frame. It is frequently located in the seat tube, the dropouts or the bottom bracket shell.

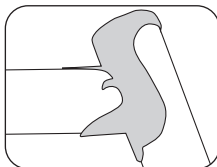

Lugged steel frame

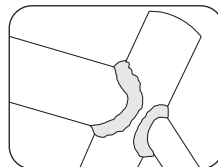

Welded aluminium frame



On no account should you ride with a bent or broken frame. Never attempt to repair damaged parts yourself. Otherwise, there is a danger of accidents. Faulty parts have to be replaced by a specialist retailer. Please only ride your bicycle again when the parts affected have been replaced.

Faults on the frame or other parts can cause accidents. If your bicycle does not ride in a straight line without any problems, this can be due to a bent frame or fork. Please contact a specialist retailer to have the frame and fork checked and possibly to have the bike realigned.

Suspension

Spring elements on the bicycle must be adjusted to the weight of the rider and the type of use. This work requires specialist knowledge and experience and should only be performed in cooperation with your specialist dealer. Carefully read the attached instructions concerning the spring elements of your bicycle.

A typical suspension fork may look as follows:

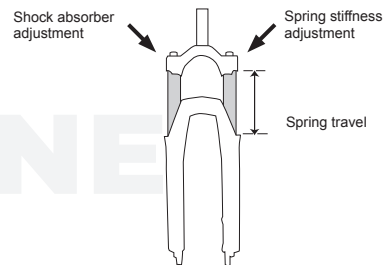

The suspension fork must be adjusted according to the fork manufacturer's operating instructions. In general, the fork should show noticeable movement when riding over uneven ground but should not "knock", i.e. be compressed to the limit stop.

A suitable basic setup would see the suspension pushed in around 10 – 15% (cross country), 15–20% (touring) or 25 – 33% (enduro, freeride, downhill) of the spring travel when the rider is sitting normally on the bicycle.



Suspension forks can only function effectively if they are regularly cleaned. Purpose-made cleaning agent or warm water with washing up liquid is suitable here. Specialist retailers also stock suitable spray lubricant for greasing your suspension regularly, both after every clean and otherwise. The same applies for suspension seat posts.



Most suspension seat posts can be adjusted to the rider's weight. However, in most cases this requires the seat post to first be extracted from the frame. Please talk to your specialist retailer before carrying this out.

Suspension frames and other suspension-related elements

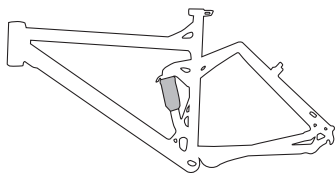

It is swivel-mounted onto the rear part of the frame and spring-suspended and damped by a shock absorber.

Shock absorbers may be based on a metal spring or an air chamber. The damping function that controls the speed during compression and

release can be adjusted on high-quality shock absorbers.

Your rear shock absorber can look like this:

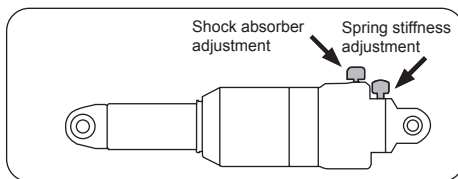

Please read the attached manufacturer's instructions for detailed information.



Avoid washing your bicycle with a high-pressure cleaner as the cleaning fluid can penetrate sealed areas due to the high pressure and then eventually destroy them.

The shock absorber's sliding pistons and gaskets should be carefully cleaned with a soft cloth as part of your regular bicycle cleaning routine. Spray lubricant on the running surface of the shock absorbers and gaskets helps keep the system working effectively. Special spray lubricant is available specifically for this purpose.



You should regularly check the links of the rear fork for play. Grip the frame securely and attempt to move the rear wheel sideways. You can also test for play in the shock absorber attachment by rapidly lifting and dropping the rear wheel. If

you a) notice play anywhere or b) hear rattling, you should immediately take your bicycle to be checked by a specialist retailer. Avoid riding the bike until it has been repaired.



The functionality and firm attachment of the spring elements is essential for your safety! Clean and check your full suspension bicycle on a regular basis! Warm water with a little washing up liquid or light cleaning agents are suitable for cleaning this part of the bicycle.



Tighten all screws to the recommended torque. Otherwise the screws could break and parts could fall off (see page 36).



Full suspension bicycles are not suitable for use with trailers and child bike trailers! The bearings and attachments are not designed to withstand this sort of force. This could result in strong wear and breaks with serious consequences.



If you have a full suspension frame with a short seat tube which is open at the bottom, the seat post can only be lowered to the point that it does not touch the spring element when it uses its full travel.

Maintenance / upkeep



Please have your bicycle checked by a specialist retailer on a regular basis. These experts can identify damaged and worn parts and are able to advise you in selecting replacements. Refrain from repairing key parts yourself (frame, fork, handlebars, stem, headset, brakes, lights).



As is the case for all mechanical parts, bikes take on wear, tear and heavy use. Because of heavy use, different materials and components can react to wear and tear in different ways. If a component is used for longer than it is designed for, it may suddenly stop working and possibly lead to injury or cause additional damage. Any kind of rip, puncture or colour change seen in an overused area indicates that the component's use has reached its limit; the component should in this case be replaced.



Screws and torque spanners

When working on the bicycle, please ensure that all screws are tightened to the correct torque. The required torque is printed on many parts with a screwed connection.

Measurements are given in Newton metres (Nm) and applied with a torque wrench. It is best to use a torque wrench that displays the tightening torque as it is in use. Otherwise screws can snap or break. If you don't own a torque wrench then you should always leave this work up to a specialist retailer!

A table listing the most important torques for bolted connections is provided on page 36.

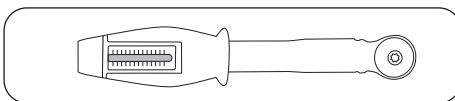

Torque spanners



Wear suitable protective clothing, protective gloves and protective goggles during all installation and maintenance work. Otherwise, contamination or injuries, that might be caused by lubricants and auxiliary materials among other things, could be the result.

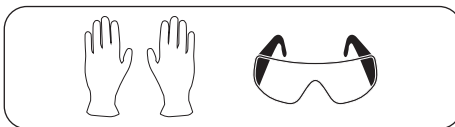

Chain

To ensure that it can work effectively, the chain has to be cleaned and greased regularly (see page 35). Dirt can be removed when washing the rest of the bicycle. Otherwise you can clean the chain by rubbing it with an oily cloth. When the chain is clean, it should be greased at the joints with suitable lubricant. After being left to soak, the excess lubricant should then be removed.

Chain tension



To ensure that the chain and gears can work safely, the chain has to have a certain level of tension. Derailleur gear systems tense the chain automatically. For hub transmissions that are mounted without a chain tensioner, the chain must be tightened if it is found sagging. Otherwise they can come off and lead to a fall.



In the case of bicycles with adjustable dropouts, the mounting screws of the axle housing should be loosened and tightened, and not the axle nuts. If the bottom bracket shell contains an eccentric bush, please tighten the chain according to the instructions provided by the corresponding manufacturer.



Please ensure that axle nuts and boosters are correctly attached!

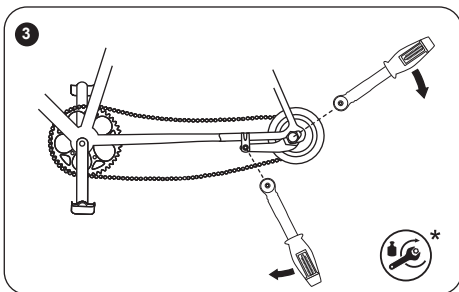
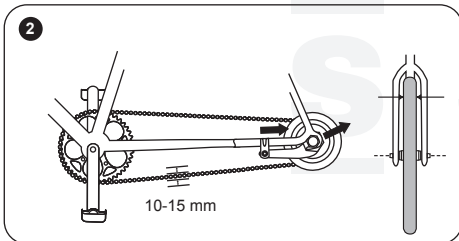
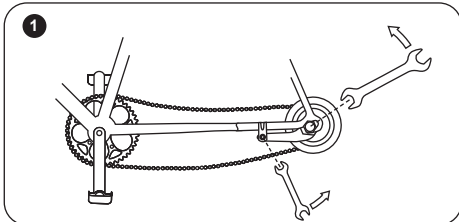

Dirt and permanent strain wear the chain. The chain should be replaced as soon as it can be significantly lifted (approx. 5 mm) from the front chain ring. Many modern chains for derailleur gear systems no longer have chain connectors. You therefore require specialist tools to open/change/close them. This work should be carried out by a specialist retailer. Other chains are supplied/assembled with chain connectors. In some cases, these can be opened without the need for tools. These chain connectors can also be used to repair a damaged chain on a ride, if they have the correct width for the drive train.

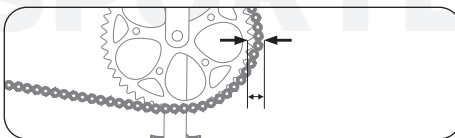

Determining chain wear

You can determine chain wear with a specialised tool.

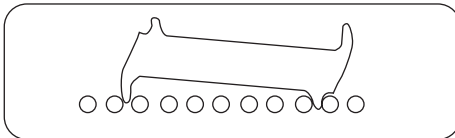

Measuring chain wear. If it is a new chain, the measuring tool will not sink in between the chain links.

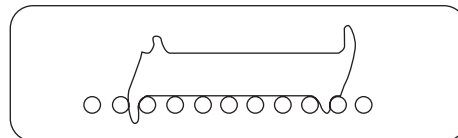

If a chain is as worn as this one, the measuring tool will sink in completely. This chain must be replaced.



If a worn chain is not replaced, the cassette and chain wheel will become excessively worn. This may result in earlier breakdowns and higher costs.

Belt drive



If your bicycle comes equipped with a converter, which makes it possible to operate hydraulic brakes with mechanical brake levers, read the attached component manufacturer's operating instructions before using it.

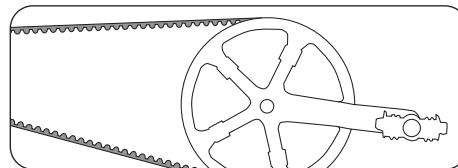

Wheels

Checking the wheels

The bicycle is connected to the ground by the wheels. The wheels are subject to a great deal of strain through the uneven characteristics of the ground and the weight of the rider.

Thorough checks and centring work on the wheels is undertaken before they are shipped. However, during the first few kilometres of riding, the spokes bed in.

- After the first 100 kilometres, the wheels have to be checked by a specialist and centred again if required.
- The tension of the spokes has to be checked at regular intervals. Loose or damaged spokes have to be replaced or centred by a specialist retailer.

The wheels can be fixed in the frame and fork in different ways. Commonly, the wheel is attached with an axle nut or a quick release. In addition, there are also various thru axle connections which are screwed in or fixed with various quick release systems. When a quick-release axle is fitted on your bicycle, you can find more information in the enclosed manufacturer's operating manual or on the respective manufacturer's website.



All screw connections must always be fastened with the correct torque. If the torque is not correct, the screws could break or loosen other parts (see page 36 "Torques for bolted connections").

Checking the hubs

You can check the hub bearings as follows:

- Lift the wheels up from the ground by first lifting the bicycle at the front then at the rear. Push each wheel to start them turning.
- The wheel should continue to turn and then slow evenly. If the wheel suddenly stops, the bearing is defective. One exception is front wheels with a hub dynamo. They have a slightly higher resistance to rolling. However, this can hardly be noticed during normal riding.
- The hub bearing should not exhibit play. Pull the wheels in the front and rear fork lightly to the sides to check if they are loose. No play may be noticeable.
- If the wheels can be slightly moved in their bearings or are difficult to turn, the hub bearings have to be set up by a specialist retailer.

Rims / tyres



Normal operation wears down brake rubbers and brake pads. You should therefore regularly check the condition of your braking system and brake pads! Replace worn brake pads and rubbers in good time! Ensure that rims and brake discs are clean and free of any oil!

Regularly clean the rims according to the inspection plan, page 33. Check the wear markers during that process:



Modern rims (from 24") indicate when they are worn from braking. These indicators take the form of embossed or coloured points or lines on the brake surfaces of the rims. When these disappear, you are no longer permitted to use the rims. There are also similar indicators which only appear after a certain level of wear. At the very latest when two pairs of brake rubbers have been worn, it is necessary to have the rims check by a specialist retailer.

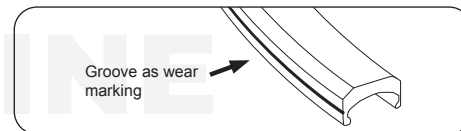

When replacing the original tires or the cranks, make sure that there is enough free space between the tires and the shoe. Accidents and severe falls could otherwise occur.



In particular, rims made of composite materials, such as carbon fibre, require special attention. Friction caused by the rim brakes, but also by simply riding the bike, puts a substantial amount of strain on the bike.

- Only use brake pads that are designed for use on the rims' material.

- Each time before riding the bike, check for wear, tear, defects, cracks and chipping on the rims and wheels when they are made of composite materials!
- If you find any changes, do not ride the bike with this part until a specialist retailer or manufacturer has checked the part and deemed it to be fully functional.
- Never expose components made of carbon fibre to high temperatures. Intense sunlight can produce high temperatures, for example when the wheel has been stored in a vehicle. This could damage the component's structure. Failing parts, falls and very serious injuries could result.



The permitted tyre pressure may not be exceeded when inflating the tyres. Otherwise this could lead to the danger of a tyre exploding. The tyres have to be pumped up with at least the stated minimum tyre pressure. If the tyre pressure is too low, there is a possibility that the tyre could free itself from the rim. If the inflation pressure rating indicated on the tyre and on the rim differ, the lower maximum pressure and the higher minimum pressure apply. If you replace the tyres, only exchange them for the same model with the same dimensions and profile. The bicycle's handling could otherwise be negatively affected. This can in turn result in accidents.



Tyres are available in various dimensions. The tyre dimensions are stated with normed information.

Example 1: "46-622" states that the tyres have a width of 46 mm and the rim has a diameter of 622 mm

Example 2: "28 x 1.60 inches" states that the tyre has a diameter of 28 inches and a width of 1.60 inches

Tyres and tyre pressure

The amounts for the recommended tyre pressure can either be named in bar or PSI. The following table presents the conversions for the usual pressure levels and shows which tyre widths these pressures should be applied to.

<i>Tyre width</i>	<i>Recommended tyre pressure</i>
20 mm	9.0 bar 130 psi
23 mm	8.0 bar 115 psi
25 mm	7.0 bar 100 psi
28 mm	6.0 bar 85 psi
30 mm	5.5 bar 80 psi
32 mm	5.0 bar 70 psi
35 mm	4.5 bar 65 psi
37 mm	4.5 bar 65 psi
40 mm	4.0 bar 55 psi
42 mm	4.0 bar 55 psi
44 mm	3.5 bar 50 psi

47 mm	3.5 bar 50 psi
50 mm	3.0 bar 45 psi
54 mm	2.5 bar 35 psi
57 mm	2.2 bar 32 psi
60 mm	2.0 bar 30 psi



Please also inform yourself using the information provided by your tyre manufacturer. This could possibly be different from the tyre pressures listed here. Not adhering to these guidelines can lead to damage to your tyres and inner tubes.

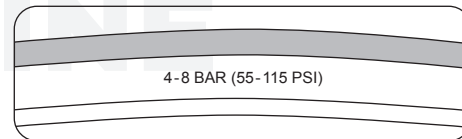

Example of tyre pressure information



Tyres are wearable parts. You should therefore regularly check the pressure, tread and condition of your tyres. Not every tyre is designed for every type of use. Allow a specialist retailer to advise you when selecting tyres.



Your bicycle can only function safely and effectively if you replace parts with suitable, authorised replacements. Please consult your manufac-

turer, importer or specialist retailer for advice on suitable replacement parts.

i Only replace broken or worn key parts with original replacement parts from the manufacturer or parts approved by your manufacturer. This is mandatory in the case of light systems, while the manufacturer's warranty is usually nullified if you install non-approved replacement parts.

i If you install non-original or false replacement parts, this can lead to severe loss of function! Tyres with poor grip or safety, brake pads with a low friction coefficient and incorrectly installed or poorly made lightweight components can all lead to potentially serious accidents. The same applies for improper assembly!

Tubeless tyres

If your bicycle is fitted with tubeless tyres, please read the instructions provided by your manufacturer covering the tyres and rims.

i Only use tubeless tyres on rims intended for this purpose! This will be marked on the rims, with the abbreviation "UST" for instance.

i Only use tubeless tyres in the prescribed way, with the correct air pressure and the recommended sealant if required.

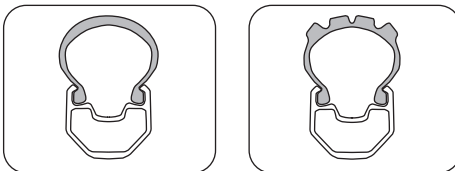

Tubeless tyres can only be mounted and removed from the rims without tools, otherwise this could lead to leaks. If the sealant is not sufficient for preventing damage, a normal tube can be used after removing the valve from the tubeless system.

Tubular tyres

Some bicycles are also fitted with tubular tyres. For more information on these, please refer to the enclosed instructions from the manufacturer.

Mountain bikes are also fitted with tubular tyres. For more information on these, please refer to the enclosed instructions from the manufacturer.



i Only use tubular tyres on rims intended for this purpose! These do not have rim flanges but smoothly curving surface, from the outside inwards. This is where the tubular tyres are fitted.

i Only use tubular tyres in the prescribed way and with the correct air pressure.

i Attaching tubular tyres requires expert skills and lots of experience! Always have your tubular tyres changed by a specialist. Inform yourself about how to handle and change this type of tyre!

Flat tyre repair for conventional tyres

You require the following equipment:

- Mounting lever (plastic)
- Patch
- Rubber solution
- Sandpaper
- Open-end spanner (for bicycles without quick-release)
- Air pump
- Replacement inner tube

1. Opening a brake

Read the description in chapter "brakes" (page 27).

2. Removing the wheel

- If your bicycle has quick-release levers or axles, open them (see page 10 and 10).
- If your bicycle has hex nuts, loosen these with a suitable spanner anti-clockwise.

You can then remove the front wheel according to the steps listed above.



Source: Shimano® techdocs

The following applies for rear wheels:

- If your bicycle uses a derailleur gear system, change gear to the smallest sprocket. In this position, the rear derailleur poses the least hindrance in removing the wheel.
- If your bicycle has quick-release levers or axles, open them (see page 10 and 10).
- If your bicycle has hex nuts, loosen these with a suitable spanner anti-clockwise.
- Pull the rear derailleur backwards somewhat.
- Lift the bicycle slightly.
- Lightly strike the wheel from above with the palm of the hand.
- Take the wheel out of the frame.

If your bicycle has a gear hub, please consult the instructions supplied by your manufacturer for removing the wheel.

Types of valve on bicycle tubes

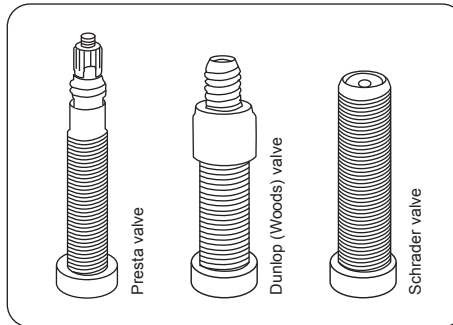

3. Removing the tyre and inner tube



For tubular tyres, see page 25

- Unscrew the valve cap, the fastening nut and possibly the cap nut from the valve. In the case of Dunlop or Woods valves, remove the valve stem.
- Release all of the remaining air from the inner tube.
- Insert the tyre lever opposite the valve on the inside of the tyre.
- Insert the second tyre lever approx. 10 cm from the first, between the rim and tyre.
- Lift the tyre wall over the edge of the rim.
- Repeat this lifting action around the wheel until the entire tyre is free.
- Remove the inner tube from the tyre.

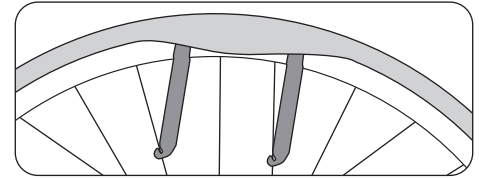

4. Change the inner tube

Switch the inner tube for an intact one.



For the change of tubular tyres and tubeless tyres follow the instructions of the rim or tyre manufacturer.

5. Reassembling the tyre and inner tube



Please avoid allowing foreign bodies inside the tyre. Ensure that the inner tube does not have any folds and is not squashed. Ensure that the rim tape covers all spoke nipples and does not have any damage.

- Place one edge of the rim into the tyre.
- Push one side of the tyre completely into the rim.
- Insert the valve through the valve hole in the rim and put the inner tube into the tyre.
- Pull the second side of the tyre into the rim with the balls of your hands.

- Ensure that the inner tube is correctly positioned.
- In the case of Dunlop or Woods valves: Push the valve stem into the right position and tighten the cap nut.
- Pump the inner tube up somewhat.
- Check that the tyre is properly in place and runs true using the control ring on the side of the tyre. Adjust the positioning of the tyre with your hand if it does not quite run true.
- Pump the inner tube up to the recommended tyre pressure.



Please take note of the running direction of the tyre when installing it.

6. Fitting the wheels

Reattach the wheel securely back in the frame or fork with the corresponding quick release, bolted connection or full floating axle mechanism.



If your bicycle has disc brakes, please ensure that the brake discs are correctly secured between the brake pads!

Read the gear manufacturer's instructions to correctly and safely assemble and set up derailleur gear systems, gear hubs and combined hub and derailleur gear systems.



Tighten all screws to the recommended torque. Otherwise the screws could break and parts could fall off (see page 36).

- Connect the brake line, attach it or close the brake quick release.
- Check if the brake pads are aligned with the brake surfaces.
- Securely attach the brake arm.
- Test the brakes.

Brakes

Modern bicycles can be equipped with a variety of different braking systems. There are various options:

Rim brakes in the form of V-brakes

If a brake pad is grazing against the rim:

The spring setting allows you to set the return force in such a way that both brake pads lift evenly from the rim when you release the brake lever. Subsequently check that the brakes are working correctly.

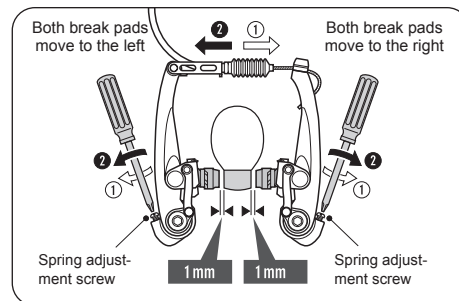
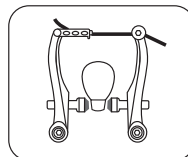

Setting up the distance between the brakes and the rim

Source: Shimano® techdocs

Cantilever brakes

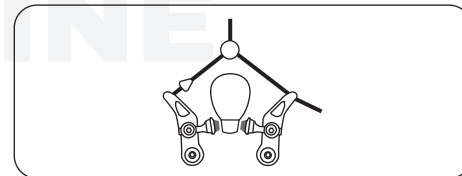

Opening the *cantilever* or *V-type* brake

- Grip around the wheel with one hand.
- Press the brake arms together and against the rim
- Detach the brake cable or the outside of the cable duct at one of the brake arms

Side-pull caliper brake

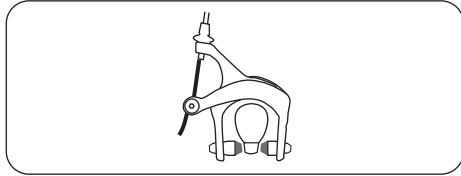

Opening the *side-pull caliper brake*:

- Open the quick release lever on the brake arm or lever, or:
- If you do not have a brake quick release, deflate all of the air out of the tyre. Now the wheel can be pulled out from between the brake pads.

Brake pad wear

The brake pads for rim brakes are almost all fitted with grooves or notches. The grooves and notches serve in part to help identify the wear level of the brake pads. If these can no longer be seen, you should replace the brake pad.



Normal operation wears down brake rubbers and brake pads. You should therefore regularly check the condition of your braking system and brake pads! Replace worn brake pads and rubbers in good time! Ensure that rims and brake discs are clean and free of any oil!

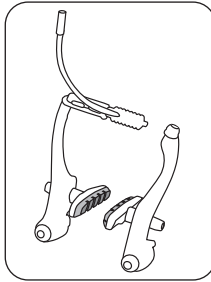

New brake pads

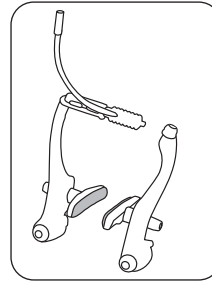

Worn out brake pad

Hydraulic rim brake

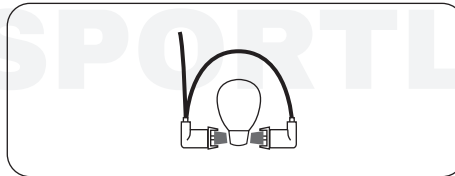

Removing the *hydraulic rim brake*:

- If your system features a brake quick release, remove the brake unit according to the instructions supplied by your manufacturer.
- If you do not have a brake quick release, deflate all of the air out of the tyre

Mechanical oder hydraulic disc brakes

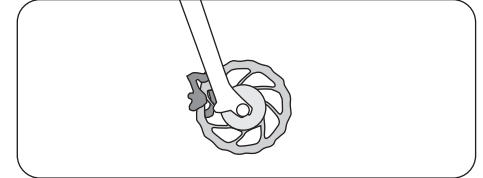

Various versions of disc brakes are available for racing and cyclo-cross bikes. Always read the enclosed instructions from the component manufacturer before the first ride. Make sure you practice and get used to operating the brakes on safe terrain before going on your first bike ride!



Disc brakes

- The wheel can be removed without any further preparation.
- Please note: when fitting the wheel, the disk must be slotted between the brake linings of the brake calliper and ultimately be centred without contact.

Vapour bubbles in the disc brakes



Avoid permanently braking for long periods, as can be the case during long, steep descents. The formation of steam bubbles and total failure of the brake system might otherwise result. This may cause severe falls and injuries.

The brake lever may not be activated when the bicycle is lying on its side or turned upside down. Otherwise air bubbles can enter the hydraulic system which could cause the brakes to fail. Test after each journey whether the pressure point of the brake feels softer than it did before. Slowly activate the brake several times. This allows the braking system to discharge any bubbles. You may not ride on when the pressure point remains soft. A specialist retailer has to discharge the air from the brake system.



You can avoid this problem by applying the brake lever before transport and then fixing it in this position using a strap. This prevents any air from entering the hydraulic system.

Read the instructions of the component manufacturer when the brake system requires cleaning.



Brake disks, in particular, are subject to wear. Please allow a specialist dealer to check these safety-related parts on a regular basis and to replace them as required.

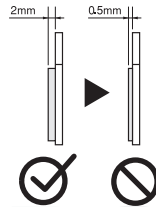

Source: Shimano® techdocs



Do not touch the brake disk while it spins or directly after braking. There is a risk of injuries or burns.



Source: Shimano® techdocs

Bedding in disc brakes

New disc brake pads and brake discs have to be carefully bedded in before the first ride. This process optimises brake performance.



The bedding-in process involves sharp braking. You must be familiar with brake performance and the operation of disc brakes. Sharp braking, without being familiar with brake performance and the operation of disc brakes, can lead to accidents causing severe or fatal injury. If you are unsure, you should have a qualified bicycle mechanic perform the bedding-in process for you.

Proceed as follows:

To bed in the brakes, accelerate the bicycle to 30 km/h and then bring the bicycle to a halt by applying maximum braking. Repeat this process around 20 times.

For optimal results, the wheels should not be allowed to lock.



Do not touch the brake disc while it is spinning or directly after braking. Otherwise injuries or burns may result.

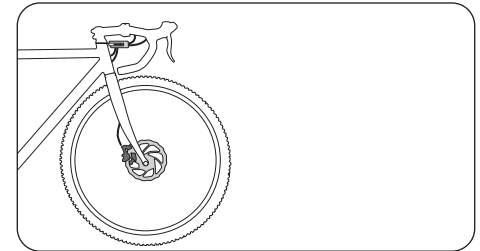



If your bicycle comes equipped with a converter, which makes it possible to operate hydraulic brakes with mechanical brake levers, read the attached component manufacturer's operating instructions before using it.

Drum brakes

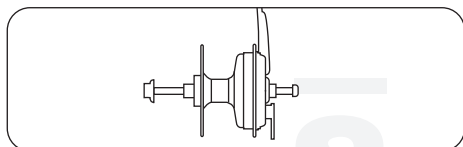

Roller brakes

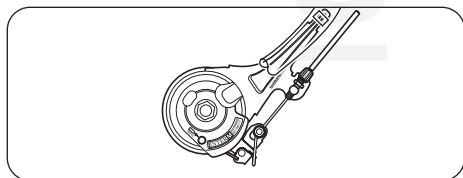

Roller brake

Source: Shimano® techdocs

Gear hubs, roller, drum or back pedal brakes are opened as follows:

- Loosen the cable anchor or quick release on the brake arm.
- In the case of back pedal brakes, the screws on the brake arm of the chain stay have to be opened.



Nearly all modern brakes have much more braking power than was available for bicycles in former times. Be careful while getting used to it. Practise the use of the brakes and emergency braking actions in traffic-free, safe terrain first before participating in road traffic.



Do not brake continuously or only with one brake when you ride on a long or very steep incline. This might lead to overheating and associated loss of braking force.

You brake correctly and safely when you use both brakes equally. The only exception is riding on slippery ground, e.g. on sand or ice. This should be done cautiously and mainly with the rear brake. There is otherwise a risk that the front wheel slides sideways and causes a fall.



Your bicycle is supplied with the corresponding operating manual for your specific gear system. You can get more information about the gears on your bicycle in the operating manual provided by your manufacturer or on the manufacturer's website.



Brakes are vital to your safety. You should therefore maintain them on a regular basis. This requires specialist knowledge and tools. Allow your specialist retailer to do this type of work on your bicycle! Work that is improperly carried out endangers your safety on the bicycle! No oil-based liquids should ever be applied to brake pads, rim brake surfaces, brake shoes or brake discs. This reduces the effectiveness of the brakes.



After any work on the brake system, perform at least one test braking action on safe, traffic-free terrain before participating in road traffic.

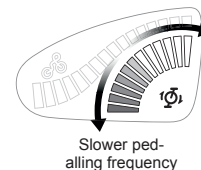

Faster pedalling frequency

Slower pedalling frequency



Have the brake fluid replaced on a regular basis. Check the brake shoes regularly and have them replaced when they are worn out. You can get more information in the brake manufacturer's operating instructions.

Gear system

This operating manual describes the use of common commercial gear components on a bicycle as an example. If your components are different, you will find specific information in the respective operating manual or on the website of the manufacturer. If you have any questions about assembling, maintaining, setting up or operating the gears, please contact your bicycle specialist retailer.

Use the shifter to change gears. Changing the gears will increase or decrease the force or speed of the bike as needed. In lower, easier gears, you can easily ride uphill and lower physical strain. In higher gears, which are harder to peddle in, you can reach higher speeds and pedal at a lower cadence. You should generally aim at riding the bike at a higher cadence and in lower gears.

Modern bicycles can be equipped with a variety of different gear systems.

There are various options:

- Chain gear:
- Hub gear:
- Combined chain and hub gear systems.
- Automatic gear changing system

These gear systems can be operated with different levers.

Gear lever, STI type, for example a Shimano lever

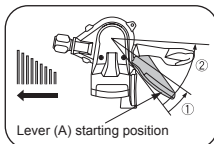

Lever (A) starting position

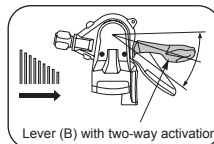

Lever (B) with two-way activation

The gear lever can be operated as shown in this example:

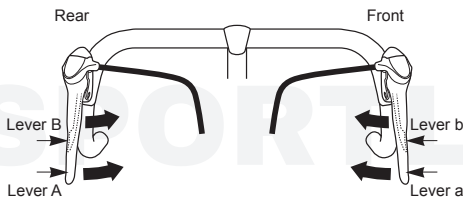

- Lever (A): Changing to a larger rear sprocket.
- Lever (B): Changing to a smaller rear sprocket.
- Lever (a): Changing to a larger chain ring.
- Lever (b): Changing to a smaller chain ring.

All levers return to their initial position as soon as they are released.

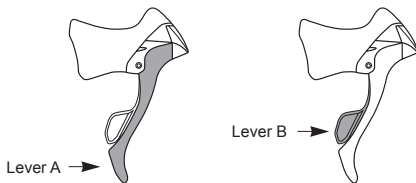

Source: Shimano® techdocs

Racing bike gear levers made by SRAM are operated in a different way, for example the RED shifter. The gear lever behind the right brake lever switches the chain on the rear sprockets. Activation with short lever movement switches to smaller sprockets and long lever movement switches to larger ones.

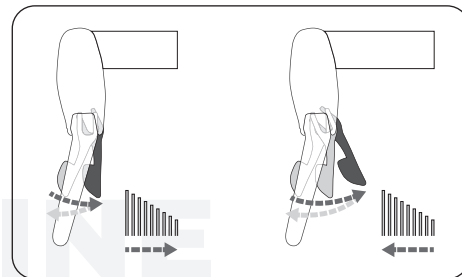

The gear lever behind the left brake lever switches to the small chain wheel after activation with short lever movement and to the large chain wheel after activation with a long lever movement.

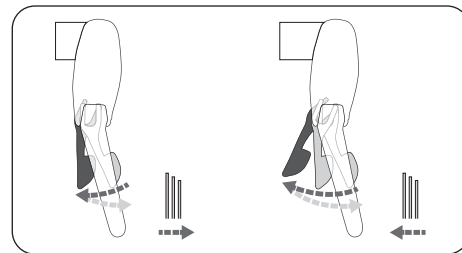

Source: SRAM®

Combination of hub and chain gear

This type of gear uses a gear hub and a derailleur. One of the advantages of this system is that there is no need for a front derailleur and therefore also little angled running of the chain. The hub gear components are operated with a thumb switcher and the chain gear system with a grip shifter or a trigger shifter in the latest models.

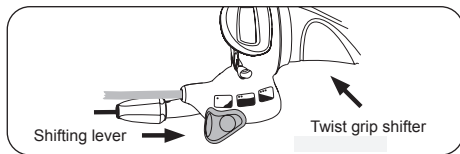

The precise approach when setting up or removing/fitting the rear wheel is explained in the enclosed instructions from the manufacturer.

Automated gear selection

This is a continuous transmission system that allows the driver to switch gears automatically or manually.

Select the Automatic mode and simply set your preferred pedalling frequency on the rotary handle; the harmony system regulates everything else. The drive automatically and continuously adjusts the transmission, so that your preferred pedalling frequency is always maintained.

Select Manual mode and directly regulate the continuous transmission on the rotary handle when you want to choose your gear ratio.



The desired gear-changing mode can be selected with a button on the rotary handle.

The display on the rotary handle shows whether the automatic or the manual mode has been selected. When the manual mode is active, you will see an orange symbol depicting a cyclist on an incline. The easier the gear selected, the further up on the incline the driver will be shown.

Manual operation

Fast transmission ratio for speed

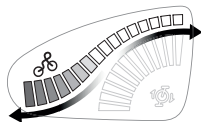

Easy transmission ratio for inclines

When the automatic mode is active, the rotary handle display will show the symbol of a crank with pedals and a quarter-circle of blue, illuminated elements. The higher the pedalling frequency you selected, the more illuminated elements will be shown.

Automatic mode

Gear shift system

As an alternative, you can have a transmission installed that operates with twist shifter. The operating instructions as well as procedure for removing/fitting the system in the case of a puncture are provided in the enclosed operating instructions. It is certainly also helpful if your specialist retailer explains the functionality to you and demonstrates removing/fitting the system.

Twist shifters

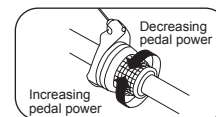
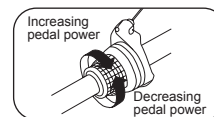

Source: Shimano® techdocs



Your bicycle is supplied with the corresponding operating manual for your specific braking model. You can get more information about the brakes on your bicycle in the operating manual provided by your manufacturer or on the manufacturer's website.



Gears are vital to your safety on the bike. Please read the operating instructions supplied to you by your manufacturer and familiarise yourself with how to operate the bicycle and switch gears before your first ride. Allow your specialist retailer to undertake any work on your bicycle's gears! Work that is improperly carried out endangers your safety on the bicycle!



Do not pedal backwards while changing gears as this could damage the gear system. Changes to the setup of your gears should only be made in small steps and with the greatest of care. Incorrect setup work can lead to the chain coming off the sprockets and causing a fall. If you are at all unsure, contact a specialist retailer who can set this up for you.



Despite a perfectly set up chain gear system, a bike chain crossing at an angle can lead to noises during riding. These noises are normal and do not cause any damage to the gear components. With less angled running of the chain in a different gear, this noise will no longer appear.

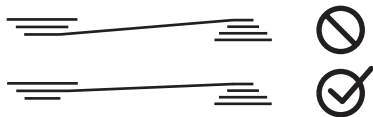

The use of spoke guards is required. For City bikes, Trekking bikes and Youth bikes they are mandatory. Otherwise, only minor setup errors could lead to the chain or the entire rear derailleur falling between the sprockets and the spokes.

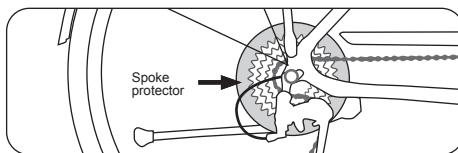

Inspection plan



Only exchange or replace components of your bicycle with components of the same brand and type. The guarantee and warranty will otherwise expire.



Modern bicycle technology is highly efficient but also sensitive. You should service your bicycle on a regular basis. This requires specialist knowledge and tools. Allow your specialist retailer to do this type of work on your bicycle! You can get more information about your bicycle's parts as well as cleaning and maintenance in the operating manual provided by your manufacturer or on the manufacturer's website.

Measures that you may perform independently without risk are marked in **bold**.

Sustainable safe function and retention of warranty claims require that you:

- **Clean your bicycle after each ride and check it for damage.**
- **Have inspections performed by a specialist dealer.**
- **Check your bicycle at intervals of approx. 300 to 500 km or every three to six months.**
- **Check that all screws, nuts and quick releases are secure.**
- **Use a torque spanner to tighten screw connections.**
- **Service and lubricate the movable parts (except the brake surfaces) according to manufacturer information.**
- **Have chips in the paint mended.**
- **Have defective and worn parts replaced.**

Deadlines and inspection work

Before every use of the bicycle:

Activity to be performed

Servicing/checks

Check:

- **Spokes**
- **Rims for wear and concentricity,**
- **Tyres for damage and foreign bodies,**
- **Quick releases**
- **Functionality of the gears and suspension**
- **Functionality of the brakes**
- **hydraulic brakes Tightness**
- **Lights**
- **Bell**
- **Tubular tyres and tubeless tyres: Safe attachment and correct tyre pressure**

When 200 km have been ridden after purchasing and then at least once per year:

Activity to be performed

Check:

- **Tyres and wheels**

Torques:

- **Handlebars** • **Pedals**
- **Crankset** • **Seat**
- **Seat post** • **all attachment screws**

Adjust the following components:

- **Headset** • **Gear system**
- **Brakes** • **Suspension elements**

After 300 to 500 km:

Activity to be performed

Check:

- **Chain** • **Sprocket** • **Rim**
- **Sprockets** • **Belt drive**
- **Brake pads for wear, exchange as required**

Cleaning:

- **Chain**
- **Sprockets** • **Sprocket** • **Belt drive**

Lubrication:

- **Chain with suitable lubricant**

Check:

- **Firm attachment of all screw connections**

Every 1000 km:

Activity to be performed

- **Check the hub brake, lubricate with brake shell grease or replace as required (specialist dealer)**

Every 3000 km:

Activity to be performed

To be checked, cleaned and replaced as required by a specialist dealer:

- **Hubs** • **Headset** • **Brakes**
- **Pedals** • **Gear system**

After riding in the rain:

Activity to be performed

Cleaning and lubrication:

- **Gear system** • **Brakes (excluding the brake surfaces)**
- **Chain**
- **Joints in the full suspension frame according to instructions from the manufacturer**



Ask your specialist dealer for suitable lubricants! Not all lubricants are suitable for all purposes. Wrong lubricants may lead to damage and reduced functionality!



The first inspection is of particular importance for problem-free and safe functioning of your bicycle. Cables and spokes stretch and bolted connections may come loose. It is essential that the first inspection should be performed by your specialist dealer.

Lubrication



Working on the bicycle requires special knowledge, experience and special tools! Only allow specialists to work or check key parts on the bicycle!

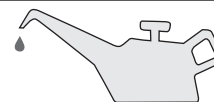

Lubrication plan

What is to be lubricated?	At what intervals?	Which lubricants are used?
Chain	After cleaning to remove dirt, after riding in the rain, every 250 km	Chain oil
Brake and gear cables	When their performance deteriorates, once a year	Silicon-free grease
Wheel bearings, pedal bearings, bottom bracket	Once a year	Bearing grease
Suspension elements	After cleaning to remove dirt, after riding in the rain, as prescribed by the manufacturer	Special spraying oil
Thread in case of installation	During installation	Installation grease
Contact surfaces of carbon fibre parts	During installation	Carbon fibre installation paste
Sliding surfaces of quick releases	Once a year	Grease, spray oil
Metal seat posts in the metal frame	During installation	Grease
Joints of gear systems	When their performance deteriorates, once a year	spray lubricant
Joints of brake systems	When their performance deteriorates, once a year	spray lubricant
Joints in the full suspension frame	When their performance deteriorates, when dirty	According to the manufacturer's instructions

Bolted connections



It is vital that all bolted connections on the bicycle have the correct torque in order to ensure that they are secure. Too much torque can damage the screw, nut or component. Always use a torque spanner to tighten screw joints. You are not able to correctly tighten these bolted connections without this specialist tool!



If a component specifies a torque for its bolted connections, then this should be strictly adhered to. Please read the instructions provided by the manufacturer, which lists the correct mounting torques.

<i>Bolted connection</i>	<i>Torque</i>
Crankset arm, steel	30 Nm
Crankset arm, aluminium	40 Nm
Pedals	40 Nm
Front wheel nut	25 Nm
Rear wheel nut	40 Nm
Stem expander bolts	8 Nm
Threadless stem clamping bolts	9 Nm
Bar ends – Clamping bolts on the bars	10 Nm

Differences for carbon components:

General torques for bolted connections

In general, the following torques can be used for bolted connections:

<i>Dimensions</i>	<i>Screw type marking</i>			<i>Unit</i>
	8.8	10.9	12.9	
M 4	2.7	3.8	4.6	Nm
M 5	5.5	8.0	9.5	Nm
M 6	9.5	13.0	16.0	Nm
M 8	23.0	32.0	39.0	Nm
M 10	46.0	64.0	77.0	Nm

* Use of carbon assembly paste is recommended

Loose accessories



You always have to fit the enclosed accessories in line with the guidelines and instructions. You have to ensure that screwed connections are secured with the correct torque (see page 36 "Torques for bolted connections").

- Only use add-on parts which satisfy the requirements of the applicable legal guidelines and road traffic regulations.
- The use of unauthorised accessories may lead to accidents or severe falls. You should therefore only use original accessories and add-on parts which fit your bicycle.
- Allow a specialist retailer to advise you.

Loose luggage rack



Only install children's trailers on bicycles which are suitable for this kind of equipment. Only use the intended fastening options. Ask your specialist dealer whether and how luggage may be transported when you have a frame and components made of carbon fibre. Never attach a baggage rack to the seat post! It is not designed for this purpose. Subjecting this part of the bicycle to excess weight with a rack can lead to breaks in the seat post and serious falls!

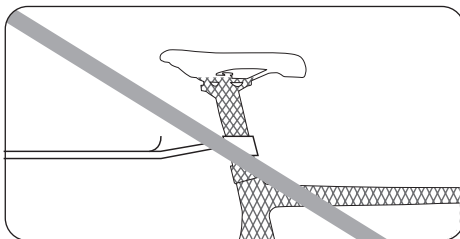

When loading luggage racks, please make sure not to cover front or rear lights or reflectors!

Avoid uneven loading of the luggage racks.

Bar ends

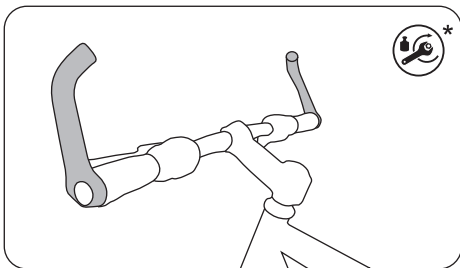

Bar ends always have to be attached to the handlebars with the correct torque, otherwise this can cause falls. Before fitting the bar ends, please inform yourself whether the add-on has been approved by the handlebar manufacturer, as only then may the bar ends be fitted.



You can not combine every frame and part made of carbon fiber! Read the manuals of the manufacturers and ask your specialized dealer.



Attached accessories

Accessories/ maintenance/ spare parts

Light system

Side dynamos are usually switched on by pressure from the top.

The switches for hub dynamos are at the rear of the headlight or on the handlebars. The light system will automatically switch on or off when it is equipped with a sensor.

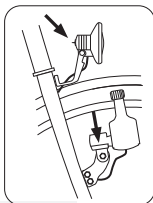

Working lights are essential for survival! Have them checked and repaired by a specialist dealer.

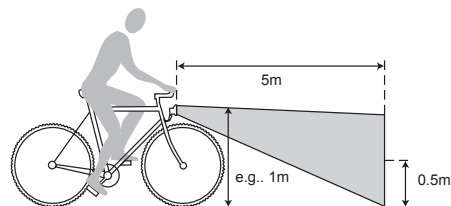

Lighting system

The type of replacement light bulbs depend on the lighting system installed in your bicycle. The following list provides a guide for finding the right bulb.

Lighting used	Technical information on the lights	
Front light	6 V	2.4 W
Front light halogen	6 V	0.6 W
Rear light	6 V	0.6 W
Rear light with standlight	6 V	0.6 W
LED lighting	LEDs cannot be replaced	
Dynamo	6 V	3 W
Hub dynamo	6 V	3 W



Please read the operating instructions supplied for your light system. If a light is not working properly, the bulb is usually broken in conventional lights. If you feel confident, you can check this yourself and install a replacement bulb. Suitable bulbs are available from your specialist retailer. It is not possible to replace the bulbs in modern LED lights.



Clean your reflectors and lights on a regular basis. Warm water with cleaning fluid or washing up liquid is suitable here. It is also important to keep the contact points in good condition with a suitable spray lubricant.

Dynamo

The dynamo generates the required electrical energy for the front headlight and the rear lights.

Hub dynamo

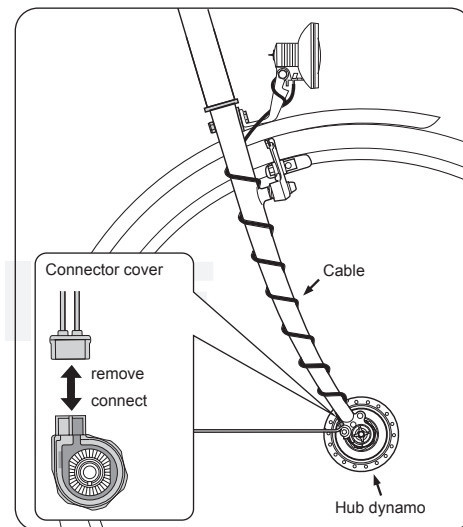

If your bicycle uses a hub dynamo, you can switch this on and off easily on the rear side of your front headlight with the on/off switch. The dynamo automatically switches on or off when the lighting system of your bicycle has a light sensor.



In order to remove the front wheel, you first have to remove the connection of the light cable.

To refit the light cable, the connecting terminal of the hub dynamo has to be fitted on the right (facing forwards). Re-attach the connections correctly and check that the lighting is working properly. To do this, turn the front wheel and check if the light comes on.

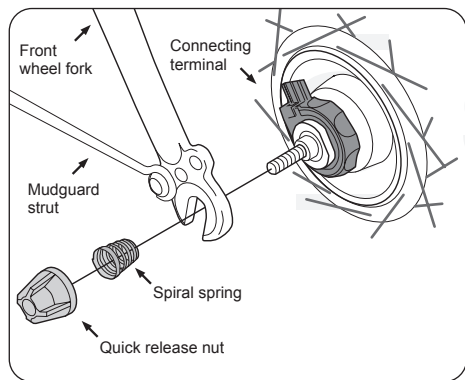

Source: Shimano® techdocs

Failure of the lighting system



The lighting system is a key part and it is vital that it is proper working condition! Only have check-up and ser-

vice work done by authorised specialist retailers after failures or temporary problems!



Clean the reflectors and headlights of the lighting system at regular intervals! Warm water and washing up liquid suffice for this job. Keep contact points clean and conductive with a suitable maintenance oil!

Your bicycle is fitted with modern lighting technology. In addition to the conventional features, it also offers you safety functions such as a standlight. This means that if you are stationary at night, e.g. at a traffic light, you are still visible to other public road traffic participants.

Equally, some models are equipped with the newly developed daytime lights. These are supplied by various energy sources depending on the riding situation. For more on this, please read the instructions supplied by the component manufacturer.

Mudguard

Mudguards are fixed correctly in place with special braces. If the inside of the mudguard runs parallel to the tyre forming a ring shape, the braces are perfectly positioned. During normal use, the mudguard should not loosen. In the case that an object becomes jammed between the mudguard and the tyre, the mudguard is fitted with a safety fastening. This releases the mudguard from its holder to prevent a fall.



You have to stop riding immediately if a foreign body is trapped between the tyre and the mudguard. The foreign body has to be removed before you can continue on your ride. Otherwise, there could be a risk of a fall and serious injuries.



On no account should you continue riding with a loose mudguard brace, as this could become wedged in the wheel and jam it.

Damaged mudguards have to be replaced by a specialist retailer before riding again. In addition, you should also regularly check whether the braces are fixed securely in the safety releases.

Re-locking a safety release

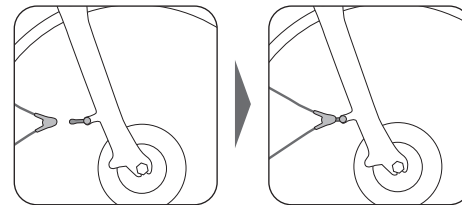

The diagram features a brace attached with a plastic clip.

- This clip is locked into the stay on the fork.
- The mudguards are aligned in such a way that they do not contact the tyres.

Rack



Transporting baggage changes the behaviour of your bicycle. In particular, it increases the braking distance, which can lead to serious injuries. Please adjust your riding style to this, i.e. brake earlier and anticipate more sluggish steering. Only transport baggage on racks intended for this purpose! Never attach a baggage rack to the seat post! It is not designed for this purpose. Subjecting this part of the bicycle to excess weight with a rack can lead to breaks in the seat post and serious falls!

- Only mount child seats on baggage racks if they have the corresponding holders and the manufacturers permit this.
- Please ensure that nothing can get caught in the spokes and turning wheels.



If you are riding with baggage, ensure that you do not exceed the maximum permissible weight of the bicycle (see page D). Information on the weight capacity of the rack is also stated here.



When loading luggage racks, please make sure not to cover front or rear lights or reflectors!

Avoid uneven loading of the luggage racks.

Front wheel rack



Front racks are attached to the front axle or the front fork. Front racks have a strong impact on the bicycle's behaviour! Please practice riding in a safe area before riding with a loaded front rack for the first time!

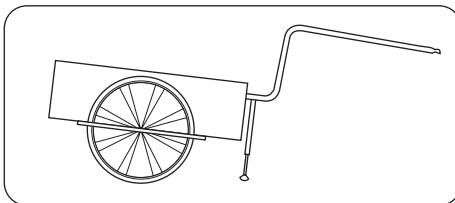
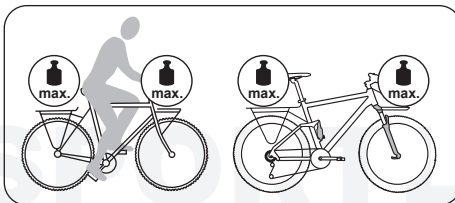

Find out whether your bicycle is approved for riding with a trailer. Your specialist dealer should have entered the relevant information on the "Hand-over documentation".

Only use approved trailers. They can, for example be identified by a GS mark. Please get advice from your specialist dealer and have the required coupling safely installed by him/her.

Take note that with a trailer your vehicle is much longer than you are used to. A bicycle with trailer also behaves differently in bends than one without a trailer. You have to get used to that when moving in road traffic. First try with an empty trailer in safe, traffic-free terrain before you participate in road traffic.



Read the manufacturer's operating instructions, which often contain important information regarding riding with a trailer. Have a look at the relevant website.

Check whether the trailer manufacturers specify a permitted maximum payload and speed. These values must be adhered to. Children under 16 years of age are not legally permitted to ride a bicycle with a trailer.

If you have purchased a time trial or triathlon bike

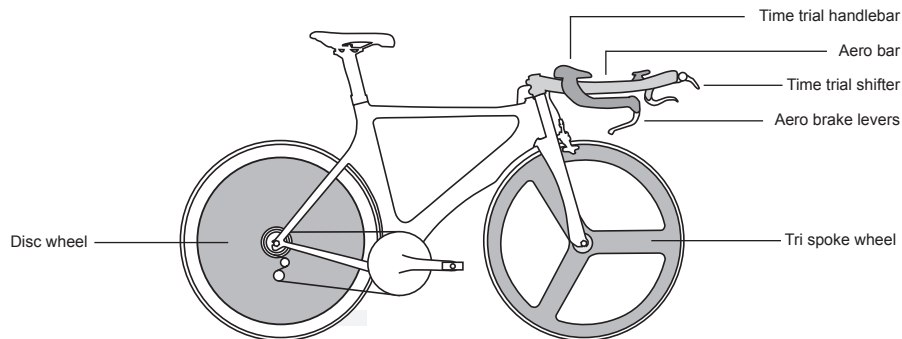

Triathlon/TT bike

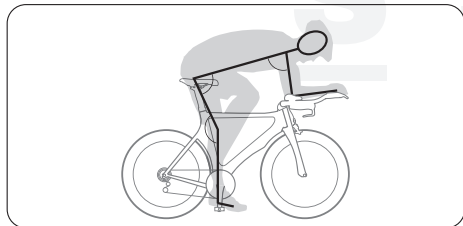

position for TT and triathlon

i The seat and handlebar position of time trial and triathlon bikes is considerably different from that of conventional racing bikes. Please allow specialists to advise you on the seating position of your time trial or triathlon bike.



The behaviour of a bicycle with a TT handlebar or attachments can be dangerously different to what you are used to. The movement required of the hands from the time trial position to the brake or gear handles is also longer and unfamiliar. Please practice this in a safe area until you have mastered the controls of the bicycle.

Disc wheels, special wheels

If your bicycle has disk wheels, tri-spokes or other types of wheels, please ensure that you familiarise yourself with how to handle and care for them.



Special wheels can behave differently than you are used to when riding, braking and steering. Trispokes and disk wheels in particular are more sensitive to wind than conventional wheels. Rims made of something other than aluminium can provide different, and perhaps considerably less effective, braking than you are used to. Familiarise yourself with your new bicycle and its behaviour in a safe, quiet area.

Electrical/electronic gear shifting system

If your bicycle is equipped with a gear system which sends its shifting signals electronically: For operation and upkeep read the enclosed instructions from the respective manufacturer. Allow a specialist retailer to work on the electronic circuit. Ask a specialist retailer to inform you about the use and maintenance of this part.

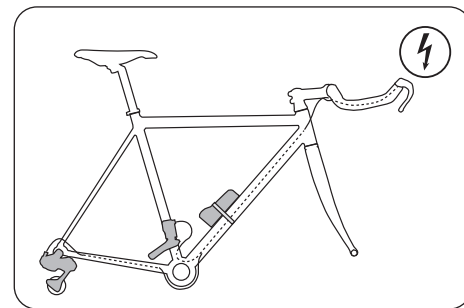

When you have purchased a BMX bicycle

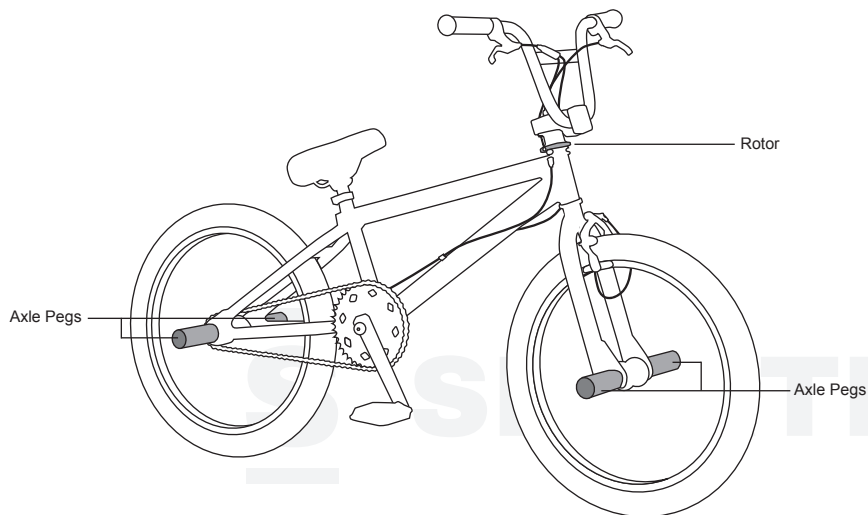

i Please note that BMX bicycles are **not** intended to be operated on a public road. BMX is a potentially risky sport. Only ride with suitable protective clothing, such as a helmet and protectors.

 Due to their special usage, large amounts of stress are placed on the axle pegs. Ensure that the components are securely fastened and regularly checked by a specialist.



The shape of the handlebars and the specialised application cause great forces to impact on the handlebars and stem. Have these parts securely attached by a specialist and checked on a regular basis.

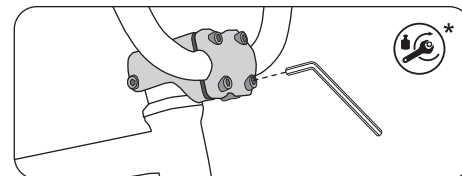

The safe fit of the brake cables in the rotor is important. Wear and tear may cause them to loosen. Ensure that the components are securely fastened and regularly checked by a specialist.

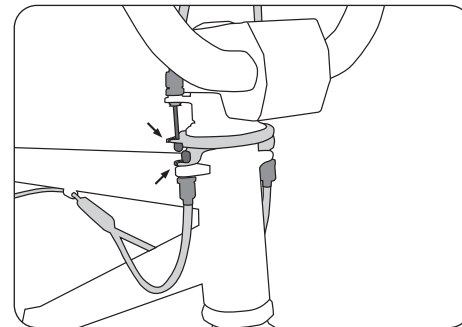
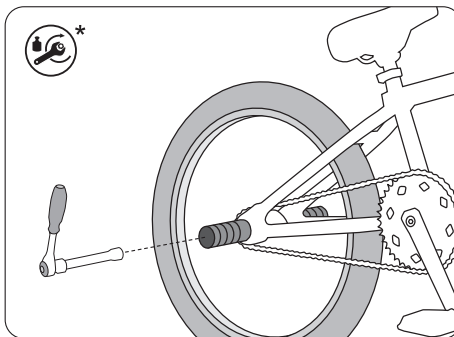

How to use carbon components



If you have a carbon frame or parts, these should not be applied with grease or oil. Please use special assembly paste for carbon parts.

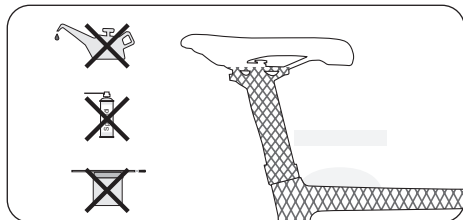

Carbon is a material which requires special handling and care during construction, servicing, riding, transport and storage.

Properties of carbon fibre



Carbon parts cannot be bent, dented or misshapen after an accident/fall. If this is the case, it is possible that the fibres have been destroyed or have broken off, e.g. within the part, which is not visible from the exterior! Therefore, it is vital to regularly check carbon frames and other carbon components very carefully, especially after a fall or an accident.

- Look for splinters, tears, deep scratches, holes or other changes in the carbon surface.

- Check if the parts have got softer or less stiff than usual.
 - Check if individual layers (paint, finish or fibres) come off.
 - Listen for any cracking or other usual sounds.
- If you are not completely certain that your bicycle is in perfect condition, please allow a specialist retailer to check the affected carbon parts!



Some carbon components require lower torques than metal parts. Excessive torques can lead to hidden damage, which is possibly not visible from the outside. Frames or components can break or warp to such an extent that you could fall. Therefore please always adhere to the instructions supplied by the manufacturer or ask for advice from a specialist. Use a torque spanner to ensure that you get the required torque. Carbon parts may not be applied with grease or oil. Special assembly paste is available for assembling and safely securing carbon components with a low mounting torque.

Never expose carbon parts to high temperatures! Even in the back of cars, the sun's rays can generate such a heat that it can put the safety of carbon parts at risk.

Do not clamp a carbon frame directly into a work stand, instead you should secure it by the seat post. If the seat post is also made of carbon, use another tube made of metal.

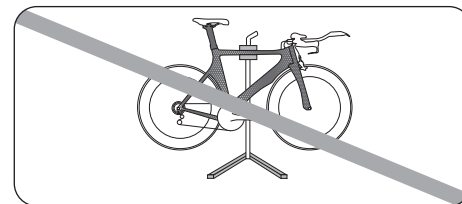

The following components and parts made of carbon fibre should be regularly checked (at least every 100 km) for irregularities such as cracks, breaks or changes to the surface, as well as after the bicycle has fallen over or following an accident:

Transition area of the threaded bushing of the drink holder, slot of the dropouts, bearing areas in full-suspension frame, suspension mounting elements on the main frame and rear suspension, seat clamp, derailleur hanger, derailleur clamp area, disc brake mounting or brake boss, press-fit area of the headset as well as the threads of the bottom bracket cups.

Carbon =



Transporting the bicycle



By car

You should only use roof and rear carriers that comply with the requirements of the Road Traffic Regulations.

Roof, rear and other carriers that are approved by the authorities are safe for use in road traffic. They must have approval according to the Road Traffic Regulations. Take note of a seal of quality like the GS mark.

Inappropriate bicycle carriers may cause accidents. Adjust your driving behavior to the load on your car roof.



The total height of your vehicle changes when you transport a bicycle on the roof!

Carefully attach the bicycle, so that it cannot come detached from the carrier. This could result in severe traffic accidents. Check the attachment several times during transport. Loose parts (tools, air pump or children's seats) may detach during the drive and put other traffic participants at risk. Remove all loose parts before driving off. The bicycle may only be attached at the handlebars, stem, bicycle seat or seat post when this is intended by the carrier manufacturer. Do not use fasteners that could damage the bicycle fork or the frame.



Never fasten the bicycle to components made of carbon fibre.

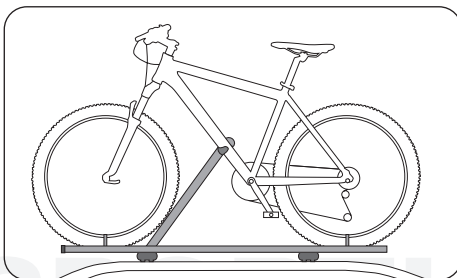

Always transport bicycles on their running surfaces when not otherwise prescribed by the carrier manufacturer. You may not attach the bicycle to the roof rack or rear carrier by its crank set. It may come loose and cause a severe accident. Bikes with a Carbon frames must not be transported with roof carriers. Most roof carriers fix the frame/bike with a clamp that fixes a frame tube. The manufacturers of add-on components and accessories also provide information regarding use and installation on their websites. Collect information when you use new components.



By train

Local public transport systems have different regulations regarding transporting bicycles. Gather information concerning the opportunities for using buses and trains before starting the trip.

The railways allow you to take bicycles along in some trains and provide special areas. Sometimes you must reserve a place for a bicycle in advance when using selected trains.



By aircraft

Check with the airline regarding the regulations for the transport of sports equipment / bicycles. You might have to register the bicycle. Carefully package the bicycle to prevent transport damage. You can use a special bicycle container or a sturdy cardboard box for transport packaging. Please talk to your specialist retailer before carrying this out.

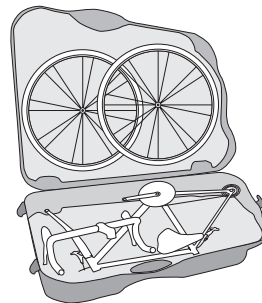

Liability for material defects (warranty)



Austria/Germany and all countries subject to EU law use partially standardized conditions regarding warranty/liability for material defects. Please inform yourself about the applicable national regulations in your specific country.

Under EU law, the seller accepts liability for material defects for at least two years after the date of sale. This also covers defects which already existed at the time of sale/change of ownership. In fact, if material defects occur within the first twelve months, the assumption is made that these already existed at the time of sale.

Bicycles are complex vehicles. Therefore it is required to implement all service intervals properly. Omitting servicing puts the claim of the seller at risk if the error could have been avoided by servicing. The necessary maintenance is outlined in the chapters of these operating instructions and in the enclosed instructions from the component manufacturers.

In most cases, the customer can first request subsequent fulfilment.

If repair fails conclusively, which is the assumption after two attempts, the customer is entitled to abatement or cancellation of the contract.

The liability for material defaults does not cover normal wear of the frame during with appropriate use. Components of the drive and the braking facilities as well as tyres, lights and contact areas between the rider and the bicycle are subject to wear due to use.

If the manufacturer of your bicycle or pedelec/e-bike provides additional guarantees, seek advice from your specialist retailer. Please consult the respective warranty terms for more information on the conditions of these and of any possible claims under these.



In the case of a defect/possible liability claim, please contact your specialist retailer. We recommend filing all purchase receipts and inspection reports as proof for your records

Environmental protection tips

General servicing and cleaning agents

Take care of the environment while servicing or cleaning your bicycle. Use biodegradable cleaning agents where possible when servicing and cleaning your bicycle. Take care that no cleaning agents are released into the drain. Use an appropriate chain cleaning device and dispose of the old chain lubricant in an appropriate manner at a suitable disposal point.

Brake cleaner and lubricants

Brake cleaners and lubricants are to be treated like general servicing and cleaning agents.

Tyres and inner tubes

Tyres and tubes may not be put into the residual or domestic waste and have to be disposed of at a recycling centre near you.

Carbon fibre parts and frames

Carbon fibre parts and frames consist of layers of carbon fibre mats that are glued together. It is recommended to have defective parts disposed of by your specialist dealer.

Battery packs and batteries

Battery packs and batteries are not residual or domestic waste and must be handed over to your specialist dealer for disposal.

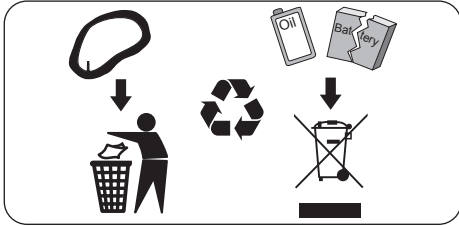

The transport packaging of this product must not be disposed of with household waste. You can return the packaging to the sender free of charge. The aim of offering this alternative option to return the used packaging is to ensure that it is collected separately from household waste so that it can be properly recycled or reused. Please note that you may need the transport packaging if you wish to return the pedelec. Please contact the manufacturer service hotline for more information.

Inspections

During the next inspection special care should be taken for:

Parts that should be changed:

Problems that occurred:

1st inspection
After approx. 200 kilometres

Work done:

Materials used:

Date, signature

Retailer stamp

2nd inspection
After approx. 1000 kilometres

Work done:

Materials used:

Date, signature

Retailer stamp

3rd inspection
After approx. 2000 kilometres

Work done:

Materials used:

Date, signature

Retailer stamp

4th inspection

Work done:

Materials used:

Date, signature

Retailer stamp

I
S **SPORTLINE**
I

Hand-over documentation

The bicycle listed in the section "Bicycle identification" was assembled properly and was delivered to the customer ready-to-use. **This complies with type _____, in the chapter "Intended Use".**

Functional checks for the following components:

- Wheels: Spoke tension, sturdiness, concentricity, correct tyre pressure
- All screw joints: secure, correct mounting torque
- Gear system
- Brake system
- Light system
- Seat position adjusted to the rider
- Suspension adjusted to the rider
- The following components were assembled and checked separately:

- The assembling/inspecting party completed a test ride
- The customer was instructed on how to use the bicycle
- Left brake lever operates front brake
- Right brake lever operates front brake

Supplied by (retailer stamp):

Date

Signature assembling party/retailer

The following operating manuals were supplied and explained:

- Bicycle
- Plus:
 - Gear system Suspension elements
 - Brake system Belt drive
 - Other documentation:

-
- | | | |
|--------------------------------|------------------------------|-----------------------------|
| Permitted for trailers | <input type="checkbox"/> Yes | <input type="checkbox"/> No |
| Permitted for child seats | <input type="checkbox"/> Yes | <input type="checkbox"/> No |
| Permitted for luggage carriers | <input type="checkbox"/> Yes | <input type="checkbox"/> No |
| Permitted for competitions | <input type="checkbox"/> Yes | <input type="checkbox"/> No |
| Authorized for Bike Parks | <input type="checkbox"/> Yes | <input type="checkbox"/> No |

The maximum total weight for this bicycle is 100 kg. The weight may vary, especially for kids' bikes and youth bikes: _____ kg (bike weight + rider + baggage + trailer).

Customer/recipient/owner

Name _____
Address _____
Postal code, Town/City _____
e-mail _____

Date of purchase

Signature recipient/owner

Bicycle identification

Bicycle manufacturer **SPORTLINE** _____

Brand _____

Model _____

Frame height/size _____

Colour _____

Frame number _____

Fork/suspension fork _____

Serial number _____

Rear shock absorber _____

Serial number _____

Gear system _____

Special features _____

In the case of change of ownership:

Owner _____

Address _____

Date/Signature _____

Line up this edge when copying

Warranty

Please unfold!
Please note the bicycle identification and handover documentation!

ADVENTURE



<https://www.adventureoutdoor.co/warranty>

GENESIS
THE ORIGINAL ADVENTURE BICYCLE BRAND



<https://www.genesisbikes.co.uk/warranty>

RIDGEBACK



<https://www.ridgeback.co.uk/warranty>

SARACEN



<https://www.saracen.co.uk/warranty>

Distributed in the UK by
Madison, A Division of H Young (Operations) Ltd,
Roebuck Way, Knowlhill, Milton Keynes, MK5 8HL
United Kingdom

adventureoutdoor.co
ridgeback.co.uk



www.sportline.co.uk



Distributed in the Europe by
Madison, A Division of H Young (Operations) (EU) Ltd,
Investment House Building, 8-34 Percy Place, Dublin 4,
Dublin, Ireland

genesibikes.co.uk
saracen.co.uk